

	文件 DOCUMENT	编号 Number	D-ASS-224-00-e
		页号 Page	2 / 90

PUNCH Powertrain

Continuously Variable Transmission

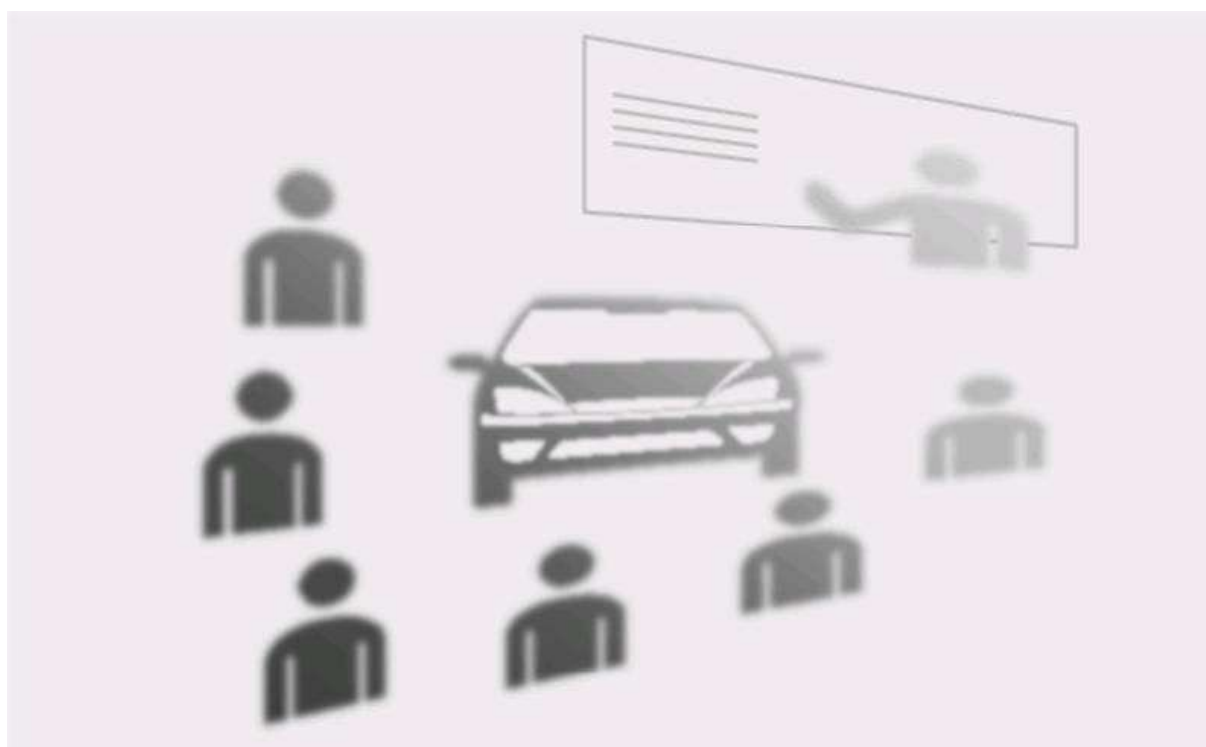

Service Manual VT2-VT3 for Haima ZZ

	文件 DOCUMENT	编号 Number	D-ASS-224-00-e
		页号 Page	4 / 90

Index

- 1. Service information.....6
 - 1.1. Towing of the vehicle.....6
 - 1.2. Service intervals6
 - 1.3. Oil specification6
 - 1.4. CNG,LPG6
 - 1.5. Wiring diagram7
 - 1.5.1. xTCU Interfaces.....7
 - 1.5.2. Transmission connector layout8
 - 1.5.3. xTCU wiring diagram9
 - 1.5.4. xTCU Connector pin assignment.....10
 - 1.6. Clutch adaptation procedure11
- 2. Service instructions14
 - 2.1. Oil refill/check instruction (refill, service transmission, new oil/oil change)14
 - 2.2. Oil level check15
 - 2.3. Shifter cable adjustment.....16
 - 2.4. Exploded view service parts.....18
 - 2.5. Service parts list and torque information19
 - 2.6. Special tools and replacement of service parts28
 - 2.6.1. Special tools28
 - 2.6.2. Instructions for replacing of the service parts34
 - 2.6.2.1. Drive shaft assembly34
 - 2.6.2.2. Replacing differential seal.....36
 - 2.6.2.3. Replacing input shaft seal.....37
 - 2.6.2.4. Replacing oil seal selector shaft39
 - 2.6.2.5. Replacing primary cover43
 - 2.6.2.6. Replacing oil pump44
 - 2.6.2.7. Replacing primary ball bearing46
 - 2.6.2.8. Replacing secondary cover50
 - 2.6.2.9. Replacing oil pan51
 - 2.6.2.10. Replacing oil filter52
 - 2.6.2.11. Replacing drive mode sensor53
 - 2.6.2.12. Replacing hydraulic unit56
 - 2.6.2.13. Replacing output speed sensor and bracket.....59
 - 2.6.2.14. Replacing primary speed sensor61
 - 2.6.2.15. Replacing main connector and internal cable harness62
 - 2.6.2.16. Replacing the breather pipe.....64
 - 2.7. Checklist of the electronic components in the transmission67
- 3. Trouble shooting guide69
 - 3.1. Leaks.....69
 - 3.2. Noise problems69
 - 3.2.1. Secondary gear sound.....70
 - 3.2.2. Reverse sound70
 - 3.2.3. Low speed gear sound70
 - 3.2.4. Primary ball bearing noise and inside bearing noise.....70
 - 3.2.5. Noise due to water or contaminated oil inside transmission72
 - 3.2.6. Noise in N or P.....73

	文件 DOCUMENT	编号 Number	D-ASS-224-00-e
		页号 Page	5 / 90

3.3. Shocks and no creep problems.....75

 3.3.1. Shocks.....75

 3.3.2. No creep.....75

3.4. P-codes and actions.....76

	文件 DOCUMENT	编号 Number	D-ASS-224-00-e
		页号 Page	6 / 90

1. Service information

1.1. Towing of the vehicle

The VT3 transmission must not be towed. This is because there is no oil pressure in the primary pulley unless the engine is running and belt slip would therefore occur. Recovery must be conducted with the front wheels lifted clear of the ground (suspended tow).

1.2. Service intervals

At least **every 2year or 60.000 km** the transmission needs a refill of the **oil** and a replacement of the **oil filter**. For this purpose, the gearbox is equipped with an oil drain plug and a top filler plug. The vehicle manufacturer can reduce the service interval of the transmission to match it with the standard service intervals for the vehicle.

1.3. Oil specification

ESSO EZL799(A).

or

IDEMITSU CVTF-EX1

or

PETRONAS Tutela Transmission CVT-PPT

The use of other oil will lead to damages in the transmission and will result in rejection of warranty claims.

Oil refill/check procedure, see service instruction 2.1

Oil level checks procedure, see service instruction 2.2

1.4. CNG,LPG

The risk of changing fuel system:

-the vehicle will has different or unstable out of torque, this will cause:

- Different performance**
- Very bad driving adaption**
- Fault code**
- Clutch problem**
- Clutch adaption problem**
- Belt slipping**

Punch does not allow changing fuel system. Please use oil which we suggest one. Use another oil will cause CVT problem, and will be out of warranty.

 <p>punch powertrain Gear up for the future</p>	<p>文件 DOCUMENT</p>	编号 Number D-ASS-224-00-e
		页号 Page 7 / 90

1.5. Wiring diagram

1.5.1. xTCU Interfaces

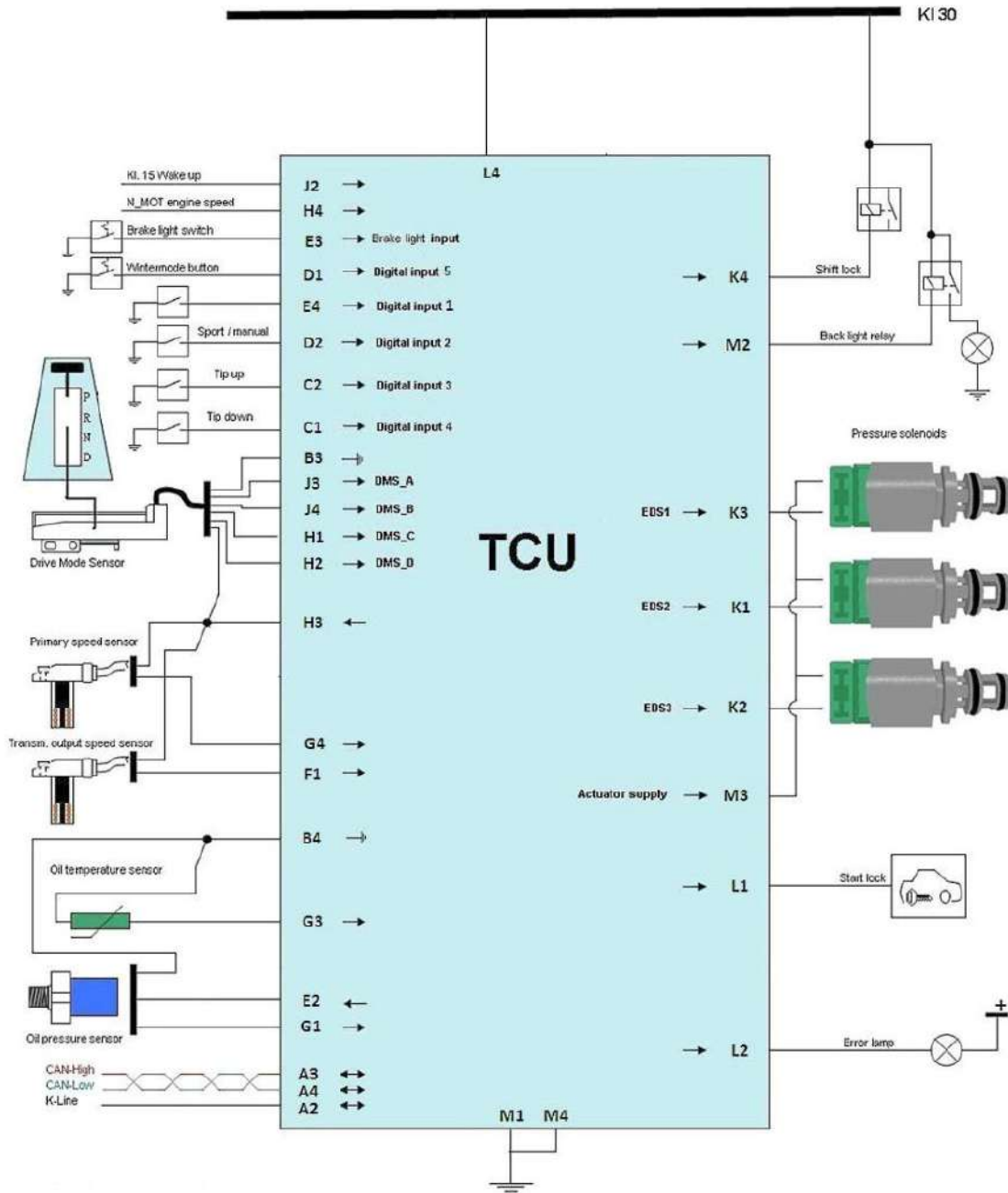

Fig.1: xTCU interfaces

	文件 DOCUMENT	编号 Number	D-ASS-224-00-e
		页号 Page	8 / 90

1.5.2. Transmission connector layout

The TCU communication with the transmission goes through a connector and is transferred through the internal cable harness. The pin layout of the connector is as shown below:

Connector Layout (transmission side)

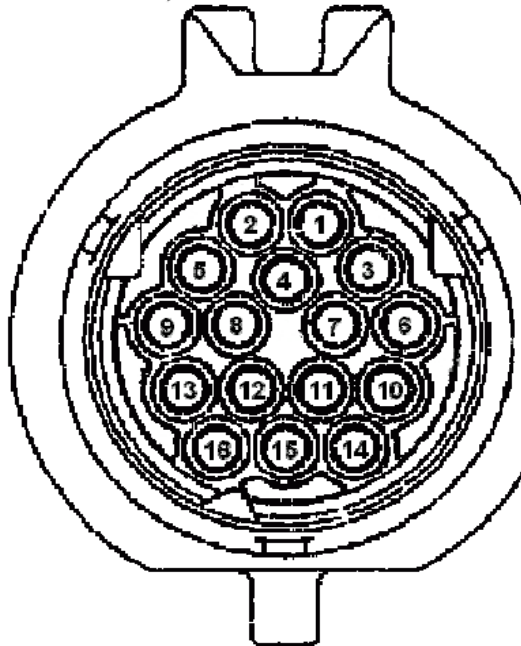

Pin assignment

Pin	Signal	Pin	Signal
1	supply valves (VHS)	9	supply_8,4V
2	EDS_1	10	p_S2
3	EDS_2	11	n_ab
4	EDS_3	12	n_S1
5	oil temperature	13	DMS_A
6	DMS_GND	14	DMS_B
7	Sensor GND	15	DMS_C
8	supply 5V	16	DMS_D

Fig. 2: The transmission connector Layout.

Signals:

DMS:	“Drive Mode Sensor” or “Position / Inhibitor sensor”
EDS_1:	Primary pressure regulator (solenoid)
EDS_2:	Secondary pressure regulator (solenoid)
EDS_3:	Clutch pressure regulator (solenoid)
P_S2:	Secondary pressure sensor
N_ab:	Secondary speed sensor
N_S1 or N_Prim:	Primary speed sensor

 <p>punch powertrain Gear up for the future</p>	<p>文件 DOCUMENT</p>	<p>编号 Number D-ASS-224-00-e</p>
		<p>页号 Page 9 / 90</p>

1.5.3. xTCU wiring diagram

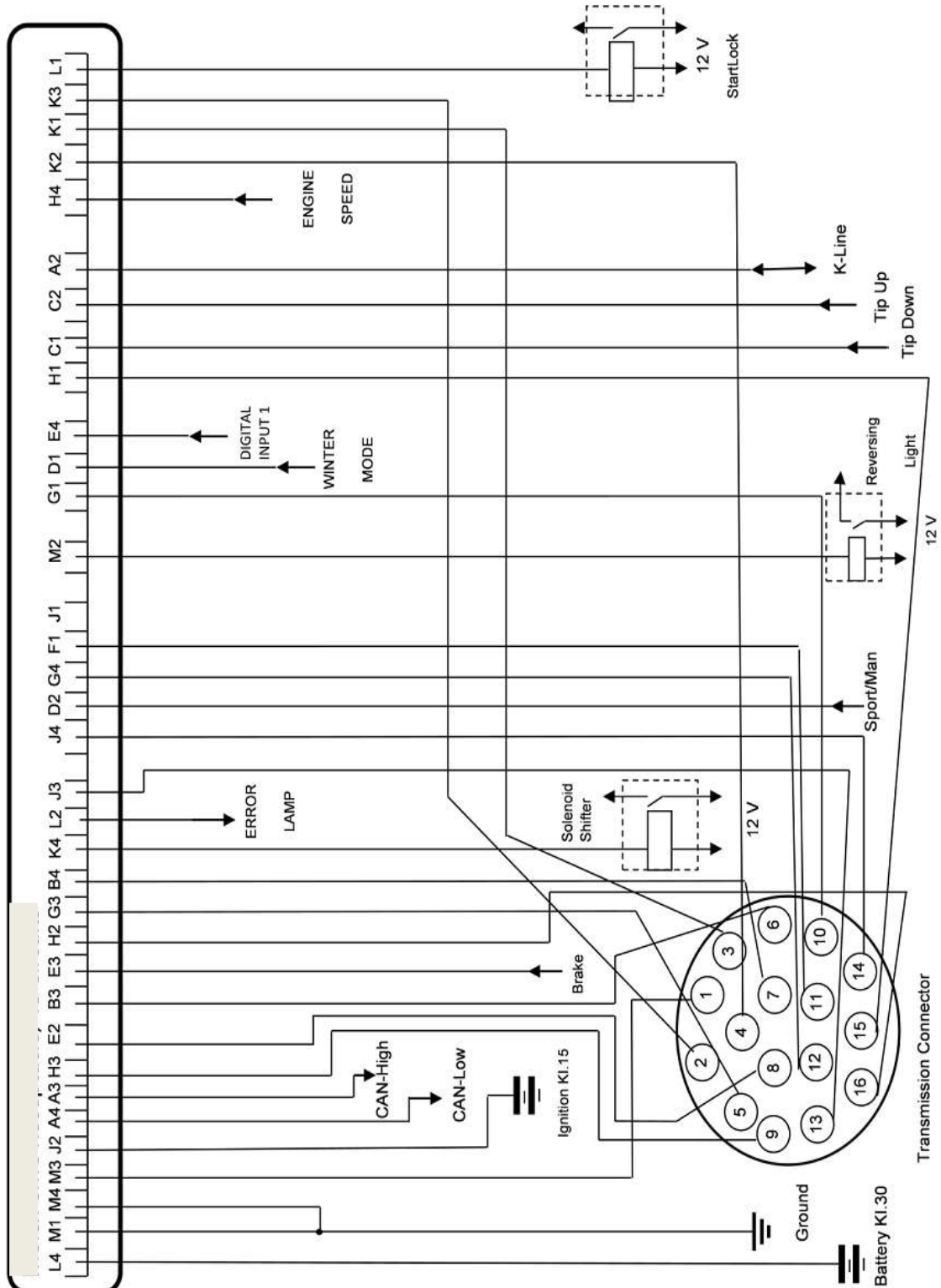

Fig.3: xTCU connection to transmission and vehicle

	文件 DOCUMENT	编号 Number	D-ASS-224-00-e
		页号 Page	10 / 90

1.5.4. xTCU Connector pin assignment

xTCU pin assignment	
VT2-VT3 – signal	xTCU Pin
Permanent Supply Kl.30	L4
Ignition Kl.15 (wake-up)	J2
Ground Kl.31	M1; M4
VHSD1 (actuator supply)	M3
Speed- & DMSensor supply (8,4V)	H3
Pressure sensor supply (5V)	E2
GND Drive mode sensor	B3
GND: Sensor Ground	B4
Transmission oil temperature	G3
N_Prim (primary speed input)	G4
N_ab (speed signal)	F1
N_MOT (engine speed signal)	H4
DMS_A	J3
DMS_B	J4
DMS_C	H1
DMS_D	H2
Dig.Inp1 (pull-up K30) (Brake signal)	E3
Dig.Inp2 (pull-up K30) (Sport/Manual)	D2
Dig.Inp3 (pull-up K30) (Tip up)	C2
Dig.Inp4 (pull-up K30) (Tip down)	C1
Winter mode / Stepped AT mode (Optional)	D1
P_S2 (secondary pressure)	G1
Shift Lock	K4
K-Line	A2
CAN-High	A3
CAN-Low	A4
Start lock	L1
EDS1	K3
EDS2	K1
EDS3	K2
Back light relay	M2
Digital input	E4
Error Lamp	L2

	文件 DOCUMENT	编号 Number	D-ASS-224-00-e
		页号 Page	11 / 90

1.6. Clutch adaptation procedure

Introduction:

After:

- uploading new software in the TCU or
- replacement of transmission or
- replacement of TCU
- replace hydraulic unit,

the clutches need an adaptation to compensate for tolerances.

This can be done by executing shift actions during idle.

The TCU warning lamp will blink at a 2 second interval until the clutch adaptation procedure is completed.

Once this procedure is completed, lifetime adaptation occurs automatically.

Pre-conditions:

These preconditions need to be met before starting the clutch adaptation procedure

- Stable torque and rotations per minute (rpm) in idle state are required. Engine adaptation needs to be completed successfully for this. For more information on engine adaptation, please refer to the Engine Control Unit (ECU) supplier's documentation.

Engine rpm requirement: ECU target value +/- 100 rpm

Engine torque requirement: ECU target value +/- 4Nm

- The transmission oil temperature needs to be between 20°C and 60°C.

In case the TCU was adapted before (uploading new software in the TCU or replacement of transmission), the TCU needs to be reset first. This is done using the MLT tool. Please refer to the MLT documentation for more information.

Procedure:

Note: prepare all things, then will carry out next step for D clutch adaption

- Vehicle speed =0km/h
- do not give gas
- brake pedal works
- shift to D

Clutch adaption procedure will auto works. If disturbs during clutch learning, the fault code FC55 (P1774) will be active, at this time the warning lamp will be on.

Everything is ok. It will take 40sec to clutch adaption in D. if clutch adaption cannot finish in 120sec, this time clutch adaption will become failure.

	文件 DOCUMENT	编号 Number	D-ASS-224-00-e
		页号 Page	12 / 90

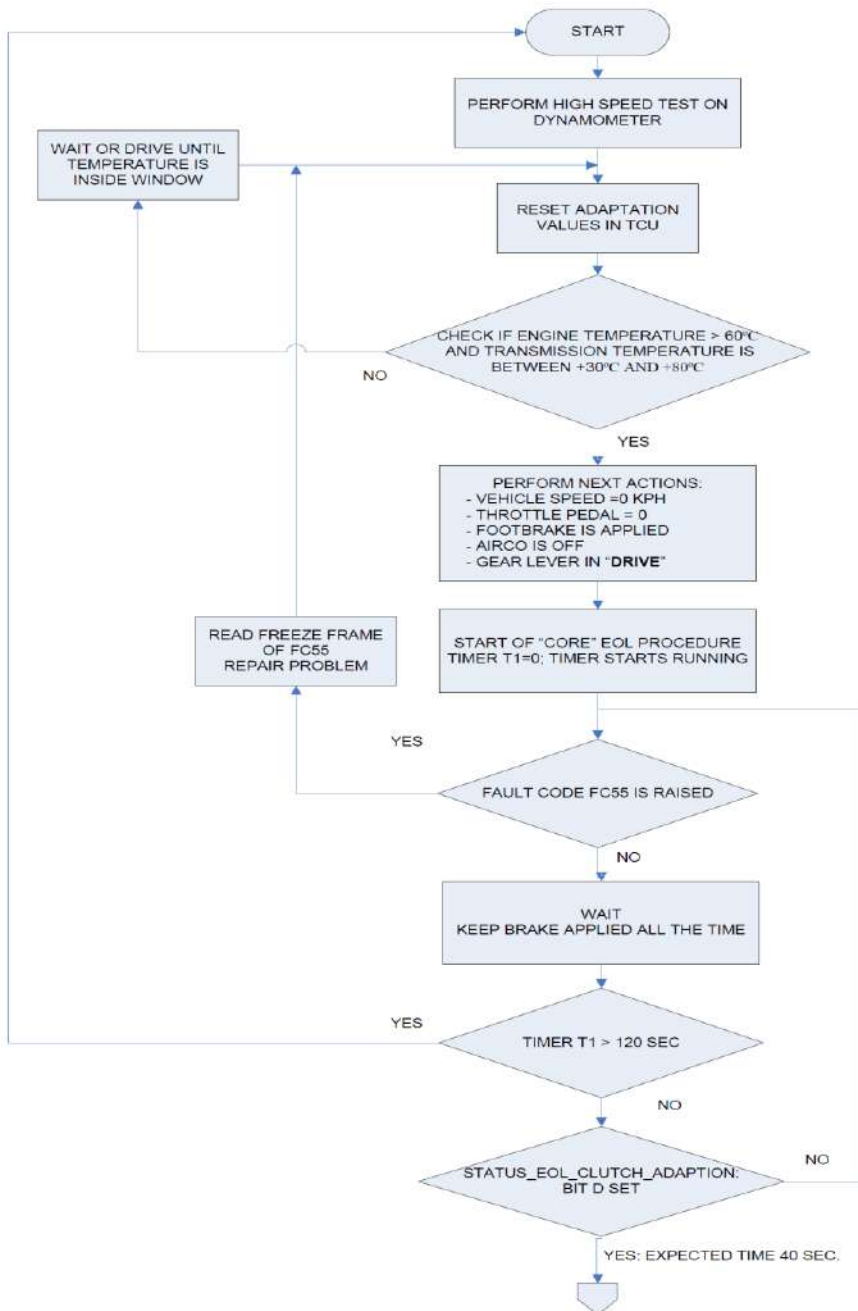

When finish D clutch adaption, now we can do R clutch adaption.

- Vehicle speed = 0km/h
- do not give gas
- brake pedal works
- shift to R

 <p>punch powertrain Gear up for the future</p>	<p>文件 DOCUMENT</p>	编号 Number D-ASS-224-00-e
		页号 Page 13 / 90

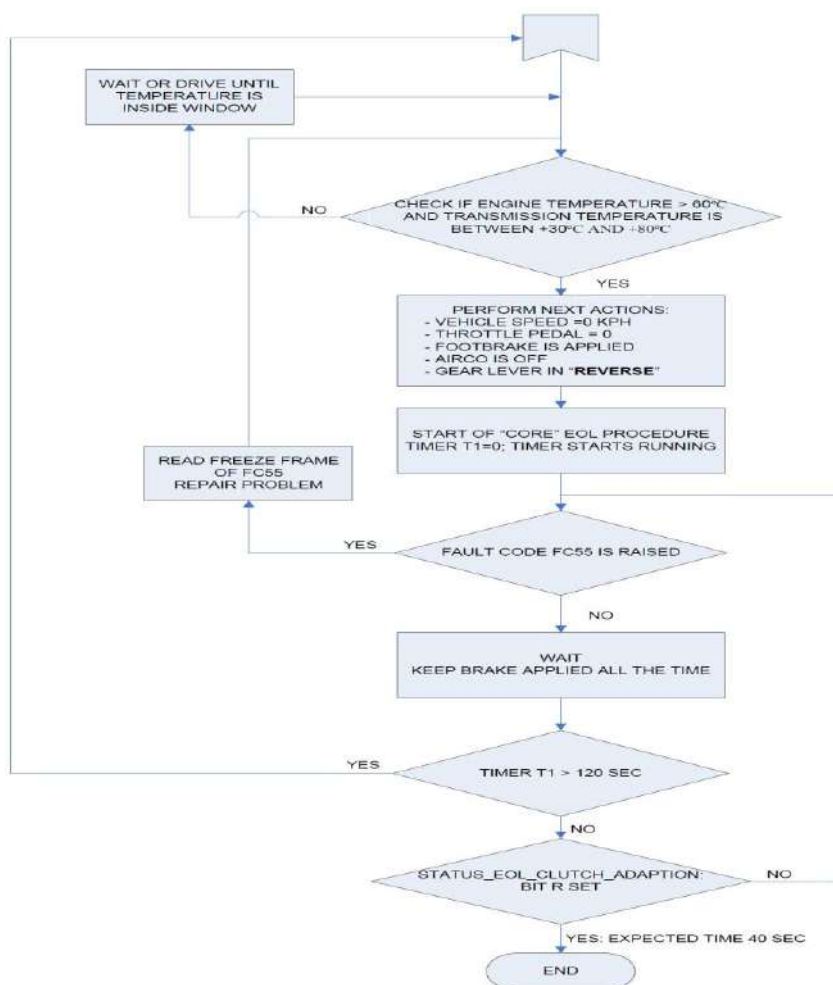

As soon as the procedure is finished (warning lamp stop blinking), the fault code P081A (EoL Clutch adaptation not finished) itself will become inactive and automatically deleted after 3 driving cycles.

Troubleshooting:

Problem	Possible Cause	Action
Warning lamp still blinking after 15 or more adaptation cycles. (Adaptation process not completed)	Transmission oil temperature is below 20°C during adaptation process.	<ul style="list-style-type: none"> - Allow the transmission to heat up (Engine on). - Restart adaptation procedure.
	Transmission oil temperature exceeds 60°C during adaptation process.	<ul style="list-style-type: none"> - Allow the transmission to cool down (Engine off). - Restart adaptation procedure.
	Instable engine torque or instable engine rpm during adaptation process.	<ul style="list-style-type: none"> - Improve engine torque and engine rpm stability. Make sure engine adaptation is completed successfully. - Restart adaptation procedure.

	文件 DOCUMENT	编号 Number	D-ASS-224-00-e
		页号 Page	14 / 90

2. Service instructions

2.1. Oil refill/check instruction (refill, service transmission, new oil/oil change)

This procedure implies whenever the oil has been drained from the transmission or transmission has been replaced with a new service transmission.

Service transmissions are not pre-filled and need to be filled up after installing in the vehicle with approximately **4.35 litres of ESSO EZL799(A) or DEMITSU CVTF-EX1 or PETRONAS Tutela Transmission CVT-PPT**

After the initial fill, the correct way to check the oil level is listed below:

- Start the engine and stay at idle for at least 10 seconds (note: air circulating through the system may be heard on initial start-up, this is a normal operating condition).
- Shift gear lever into each position (P-R-N-D) and allow the gear to rest in each of its position for 5 seconds before progressing to the next position.
- Move the gear lever into 'D' position.
- Release the foot brake.
- Apply a little throttle to at least 60 km/h (the engine speed must not be higher than 2500 rpm).
- Release the throttle and slightly break to a standstill (all the noises by air circulating in the system during the first up shifting should be gone).
- To increase the oil temperature, drive carefully around for at least 5 minutes or until the temperature of the transmission has reached approximately 60°C.
- Place the car on a flat ground.
- Apply the foot brake.
- Wait two seconds
- Move the gear lever into 'R' position.
- Wait 10 seconds.
- Move the gear lever into 'P' position.
- **Keep the engine running idle.**
- Remove the oil level plug (2)
- Make sure minimum 0,2 litres of oil flows out of the oil level tube after removing the level plug (otherwise the initial amount of oil wasn't sufficient). If not, add another 0.5 litre extra and redo complete procedure.
- Wait a few minutes until the oil that comes out of the level begins to drip
- Refit the oil level plug with a **new** sealing ring (**18-24Nm**).
- Shutoff the engine.

	文件 DOCUMENT	编号 Number	D-ASS-224-00-e
		页号 Page	15 / 90

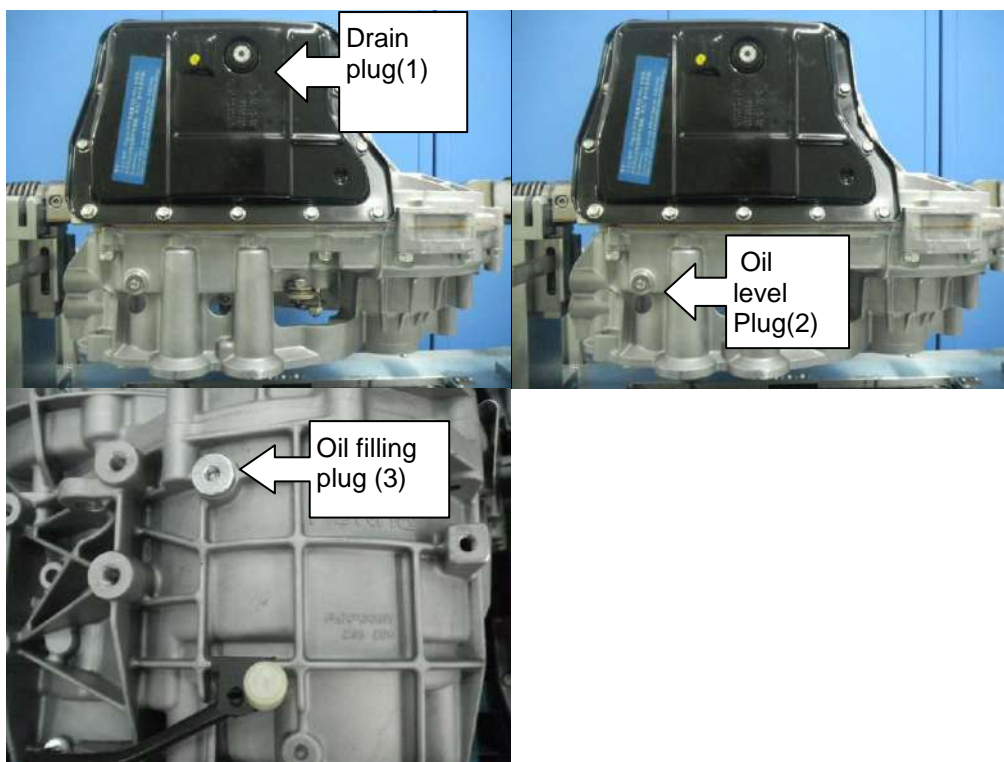

2.2. Oil level check

If the initial fill was done properly, the oil level will be at a correct level (“level-plug” level)

Due to tolerances (such as: new transmissions are delivered with a residual oil volume and initial fill tolerances) the tolerance on the correct “level-plug”-level will be ± 0.165 liter.

In case of an oil level check proceed as follow:

- Remove the oil filling plug (3) on top of the transmission
- Fill the transmission with exactly **0.5 Litre**
- Refit the oil filling plug (3) together with a **new** sealing ring (**18-24Nm**)
- To increase the oil temperature, drive carefully around for at least 5 minutes or until the temperature of the transmission has reached approximately 60°C.
- Place the car on a flat ground.
- Apply the foot brake.
- Wait two seconds
- Move the gear lever into ‘P’ position.
- **Keep the engine running idle.**
- Remove the oil level plug (2), while engine running idle
- Collect the drained oil (min 0.335 Litre and max 0.665 Litre)

-Minimum **0.31 litre** ($0.5_{\text{ADDED OIL}} - 0.19_{\text{tolerances}} = 0.31 \text{ Litre}$) oil will drain out off the transmission. If the collected amount is less:
the initial level was too low.

	文件 DOCUMENT	编号 Number	D-ASS-224-00-e
		页号 Page	16 / 90

-Maximum **0.64 litre** ($0.5_{\text{ADDED OIL}} + 0.14_{\text{tolerances}} = 0.64 \text{ Litre}$) oil will drain out off the transmission. If the collected amount is more:
the initial level was too high.

Mentioned values are valid for exactly 60deg.

- Refit the oil level plug (2) with a **new** sealing ring (**18-24Nm**)
- Shutoff the engine.

2.3. Shifter cable adjustment

This procedure describes how to connect the shifter inside the car correctly with the transmission. If this is not done according following instruction, it is possible that the transmission is in another state (PRND) than the driver (or shifter) wants. The dashboard will always indicates what the state is of the transmission, regardless what the position of the shifter is. For a good cable adjustment the dashboard and shifter will indicate the same position (PRND).

- Put the shifter in P position
- Make sure the transmission is in P position, shift lever to the complete outer position like on the picture:

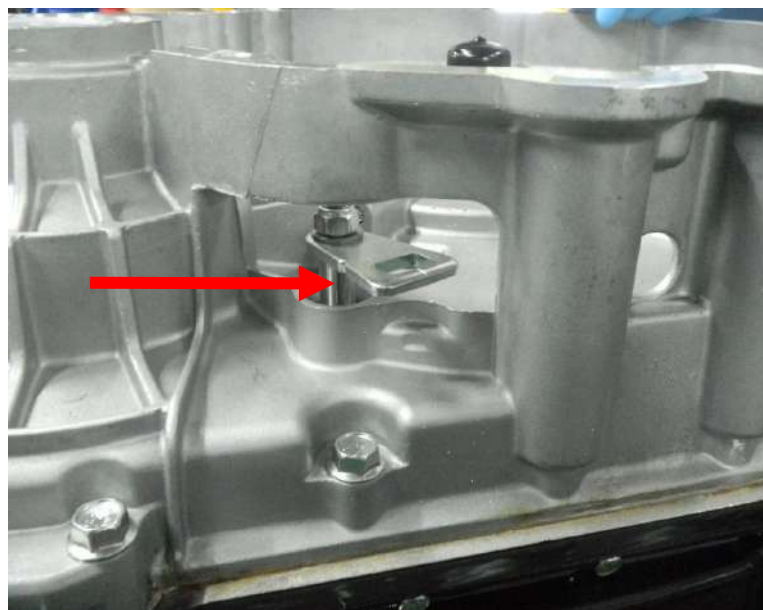

Shift lever in P position for cable adjustment

- If the shift lever is not in this position, push the shift lever manually to the outer right position:

	文件 DOCUMENT	编号 Number	D-ASS-224-00-e
		页号 Page	17 / 90



Shift lever NOT in P position, NOT OK for cable adjustment

- The P position can be verified by checking the indication on the dashboard.
- Turn both front wheels at the same time till they are locked. Now the transmission is locked in P position. You can still however turn the shift lever out of P position but do not do this at this moment.
- If there is a bracket to hold the cable, connect first the cable to the bracket.
- Connect now the cable to the shift lever with screw and nut.
- When tightening the screw, do not bend the cable or the shift lever!!

The shifter inside the car is now aligned with the transmission and dashboard will show the same position like the shifter.



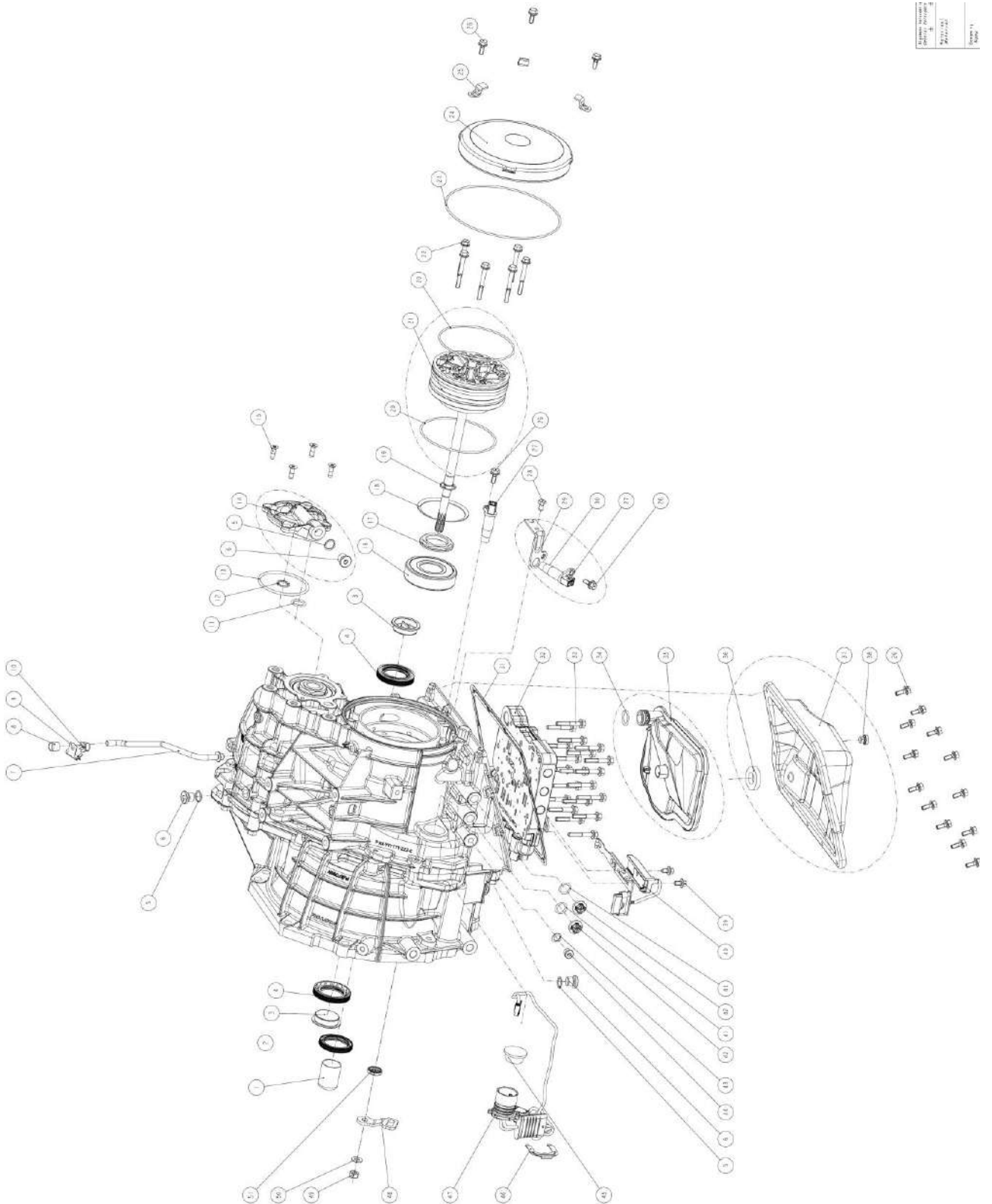

	文件 DOCUMENT	编号 Number	D-ASS-224-00-e
		页号 Page	18 / 90

2.4. Exploded view service parts





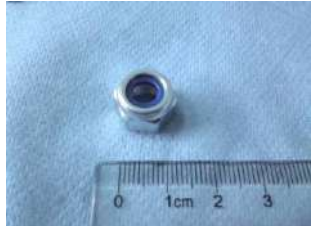



	文件 DOCUMENT	编号 Number	D-ASS-224-00-e
		页号 Page	19 / 90

2.5. Service parts list and torque information

Item 4 482871	Oil seal differential	
Item 2 481274	Oil seal input shaft	
Item 48 482584	Washer shift lever	
Item 46 481329	Nut M8 self locking shift lever (14,5 +/-1,5 Nm)	
Item 49 482099	Oil seal selector shaft	
Item 47 484624	Shift lever	







	文件 DOCUMENT	编号 Number	D-ASS-224-00-e
		页号 Page	20 / 90

Item 22 481173	Primary cover	
Item 23 481189	Clip primary cover	
Item 54 481253	O-ring primary cover 177,47 x 2,62	
Item 24 481283	Bolt primary cover M6x16 (9,5 +/-2,5 Nm)	
Item 18 481259	O-ring oil pump	
Item 20 481284	Bolts oil pump (10 +/-1 Nm)	
Item 15 481293	Primary nut (197,5 +/-17,5 Nm)	

	文件 DOCUMENT	编号 Number	D-ASS-224-00-e
		页号 Page	21 / 90

Item 17 481826	Sealing ring oil pump	
Item 16 481856	Belle-ville washer	
Item 19 483323	Oil pump (incl. O-rings)	
Item 14 482294	Primary ball bearing	
Item 5 481247	Sealing ring plug M14	
Item 6 481248	Plug M14 (21 +/-3 Nm)	



	文件 DOCUMENT	编号 Number	D-ASS-224-00-e
		页号 Page	22 / 90

Item 41 481249	Sealing ring plug M10	
Item 42 481250	Plug M10 (15 +/-2,25 Nm)	
Item 12 483616	Secondary cover	
Item 55 481254	O-ring secondary cover 17.12 x 2.62	
Item 56 481255	O-ring secondary cover 72.63 x 3.53	
Item 10 481877	Sealing ring secondary cover	







	文件 DOCUMENT	编号 Number	D-ASS-224-00-e
		页号 Page	23 / 90

Item 13 482208	Countersunk head screw M6 x 20 (9,5 +/-0,95 Nm)	
Item 33 483165	Oil filter (incl. O-ring) (M6, S5)	
Item 33 482456	Oil filter (incl. O-ring) (M3)	
Item 24 481283	Flanged bolt oil pan M6x16 (9 +/-1 Nm)	
Item 29 482504	Gasket oil pan	
Item 34 481870	Magnet oil filter	
Item 36 482442	Drain plug (11 +/-1 Nm)	





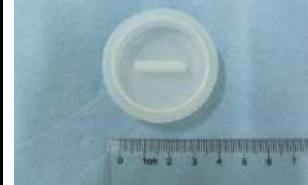

	文件 DOCUMENT	编号 Number	D-ASS-224-00-e
		页号 Page	24 / 90

Item35 483167	Oil pan cpl (magneet +drain plug) (M6, S5)	
Item 35 482489	Oil pan cpl (magneet +drain plug) (M3)	
Item 30 482589	Valvebody cpl	
Item 31 481311	Bolt valvebody (11 +/-1 Nm)	
Item 38 483444	Position switch cpl	
Item 37 481090	Bolt position switch (9,5 +/-0,95 Nm)	
Item 27 482468	Bracket output speed sensor	

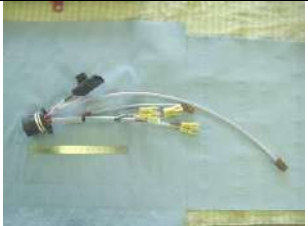



	文件 DOCUMENT	编号 Number	D-ASS-224-00-e
		页号 Page	25 / 90

Item 26 481289	Bolt bracket output speed sensor (9,5 +/-0,95 Nm)	
Item 25 483516	Input/output speed sensor	
Item 24 481283	Bolt speed sensors (8,5 +/- 2 Nm)	
Item 39 481258	O-ring plug oil cooler connection	
Item 40 482121	Plug oil cooler connection	
Item 1 482235	Plug input shaft	
Item 3 481296	Plug output shaft	

	文件 DOCUMENT	编号 Number	D-ASS-224-00-e
		页号 Page	26 / 90

Item 44 482105	Clip main connector	
Item 45 482475	Main connector and internal cable harness	
Item 8 483114	Breather pipe assy.	
Item 7 483420	Breather cap	
Item 51 481456	Clip (metal)	
Item 43 482104	Cover cable harness	
Item 52 482253	Clip breather pipe (plastic)	

	文件 DOCUMENT	编号 Number	D-ASS-224-00-e
		页号 Page	27 / 90

483480	xTCU (M3)	
483490	xTCU (M6)	
483491	xTCU (S5)	
483477	M3 New Transmission (no TCU)	
483492	S5,M6 New Transmission (no TCU)	

	文件 DOCUMENT	编号 Number	D-ASS-224-00-e
		页号 Page	28 / 90

2.6. Special tools and replacement of service parts

2.6.1. Special tools



Plug – Primary bearing (drawing 480139)



Stamp – oil seal selector shaft (drawing 480125)

	文件 DOCUMENT	编号 Number	D-ASS-224-00-e
		页号 Page	29 / 90



Stamp – Primary bearing (drawing 480137 + 480126)



Removing tool – primary bearing (drawing 480136)

	文件 DOCUMENT	编号 Number	D-ASS-224-00-e
		页号 Page	30 / 90



Stamp – oil seal input shaft (drawing 480130)



Centering bush – oil seal input shaft (drawing 480129)

	文件 DOCUMENT	编号 Number	D-ASS-224-00-e
		页号 Page	31 / 90



Removing tool – oil seal selector shaft (drawing 480127)



Centering pin – hydraulic unit (drawing 480142)

	文件 DOCUMENT	编号 Number	D-ASS-224-00-e
		页号 Page	32 / 90



Stamp – oil seal differential (drawing 480143)



Removing tool – pump (drawing 480141)

	文件 DOCUMENT	编号 Number	D-ASS-224-00-e
		页号 Page	33 / 90



Assembly tool – breather pipe (drawing 480140)



Assembly tool drive shaft (drawing 48154)

Note: Pictures can differ from actual tools and drawings!!

	文件 DOCUMENT	编号 Number	D-ASS-224-00-e
		页号 Page	34 / 90

2.6.2. Instructions for replacing of the service parts

2.6.2.1. Drive shaft assembly

During the assembly of the drive shafts into the transmission, we strongly recommend to use Punch Tool 480145 in order to protect the oil seal at the differential.

When the driveshaft should damage the oil seal, oil leakage is the unavoidable consequence.

Using this tool will significantly reduce the chance of damaging the oil seal.

-Remove the protection covers:



Fig. 1-1: Protective covers for differential seal

-Install tool 480145 over the output seal:



Fig. 1-2: Assembly tool drive shaft 480145 mounted

	文件 DOCUMENT	编号 Number	D-ASS-224-00-e
		页号 Page	35 / 90

-Insert drive shaft for max 4cm into the transmission:



Fig. 1-3: Drive shaft inserted for 4cm

-Stop and leave 2 cm distance between the driveshaft and mounting tool:



Fig. 1-4: 2 cm distance between drive shaft and tool 480145

-Remove the tool 480145

	文件 DOCUMENT	编号 Number	D-ASS-224-00-e
		页号 Page	36 / 90

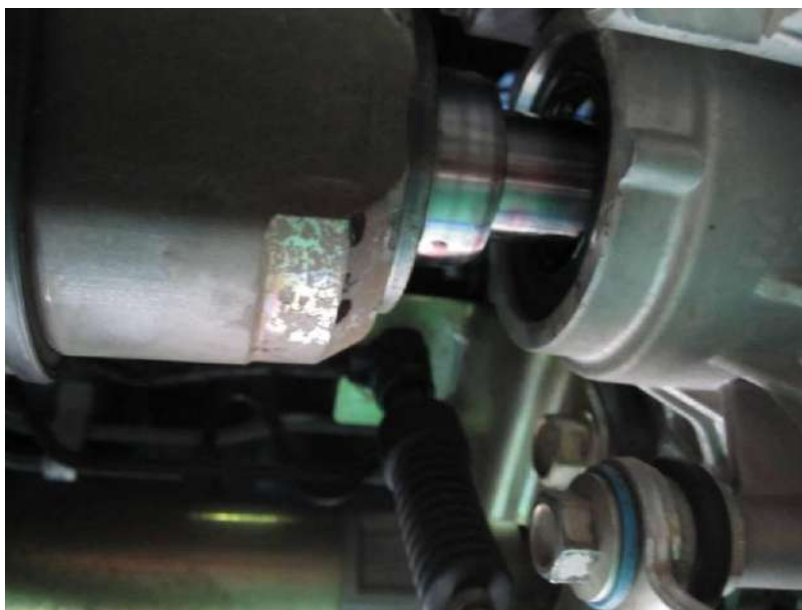

Fig. 1-5: Tool 480145 removed

-Push driveshaft completely into the transmission:



Fig. 1-6: Drive shaft mounted

2.6.2.2. Replacing differential seal

When:

In case of damage/leakage on seal or half shaft.

How:

- Drain the oil of the transmission (see changing oil filter)
- Remove half shaft
- use a big screwdriver to pinch out the seal. Be careful not to put screwdriver in too deep, otherwise the housing can be damaged by the tip of the screwdriver (see Fig. 2-1)
- Discard the old oil seal

	文件 DOCUMENT	编号 Number	D-ASS-224-00-e
		页号 Page	37 / 90

- Take a new seal and put it in the housing (see Fig. 2-2)
- Place the special tool (480143) on the seal and use a rubber hammer to knock oil seal into the housing. Hammer it all the way in until no further is possible
- The depth of the oil seal should now be $3\text{mm} \pm 0.3\text{mm}$ from the edge of the housing
- Replace the half shaft if necessary
- Refill transmission according instruction (see 2.1)



Fig. 2-1: Remove oil seal



Fig. 2-2: Installing new seal with special tool

2.6.2.3. Replacing input shaft seal

When:

In case of damage or leakage on seal

How:

- Drain the oil of the transmission (see changing oil filter)

	文件 DOCUMENT	编号 Number	D-ASS-224-00-e
		页号 Page	38 / 90

- Remove the transmission from the car
- Use a big screwdriver to peel out the seal from the transmission (see Fig. 3-1). Peel out the seal from the inside of the seal by going around and around. Be careful not to damage the input shaft
- Discard the old oil seal



Fig. 3-1: Remove input shaft seal

- Place the special guiding tool (480129) on input shaft (see Fig. 3-2)
- Slide a new seal over the guiding tool (see Fig. 3-3)



Fig. 3-2: Put special tool on input shaft (480129)

	文件 DOCUMENT	编号 Number	D-ASS-224-00-e
		页号 Page	39 / 90



Fig. 3-3: Press the oil seal

- Place the special stamp tool (480130) on input shaft (see Fig. 3-4)
- Hit the special stamp tool with rubber hammer until no further is possible
- Remove special tools and refit transmission in vehicle
- Refill transmission according instruction (see 2.1)



Fig. 3-4: Installing seal by special stamp (480130)

2.6.2.4. Replacing oil seal selector shaft

When:

In case of leakage on oil seal selector shaft

How:

- Drain the oil of the transmission (see changing oil filter)
- Remove the transmission from the car
- Remove lever selector shaft
- Place special tool (480127) over the selector shaft (see Fig. 4-1)

	文件 DOCUMENT	编号 Number	D-ASS-224-00-e
		页号 Page	40 / 90

- Screw in the special tool with wrench. Push on top of the wrench so the tool has the ability to screw itself into the seal (see Fig. 4-2)
- Screw in the screw on top of the special tool to lift out the seal (see Fig. 4-3)
- Discard the seal (see Fig. 4-4)



Fig. 4-1: Put special tool (480127) on shaft



Fig. 4-2: Press and screw tool clockwise

	文件 DOCUMENT	编号 Number	D-ASS-224-00-e
		页号 Page	41 / 90



Fig. 4-3: Rotate screw to remove the seal



Fig. 4-4: Remove the oil seal

- Put some vaseline or grease on the tip of the stamp (480125) (see arrow in Fig. 4-5)
- Take a new seal and slide it over the special stamp (480125) (see Fig. 4-5).
- Place special stamp tool (480125) with seal over the selector shaft and hammer in the seal until no further possible (see Fig. 4-6 and 4-7).
- Pull out the special stamp tool (480125)

	文件 DOCUMENT	编号 Number	D-ASS-224-00-e
		页号 Page	42 / 90



Fig. 4-5: Slide the seal over the special stamp (480125)

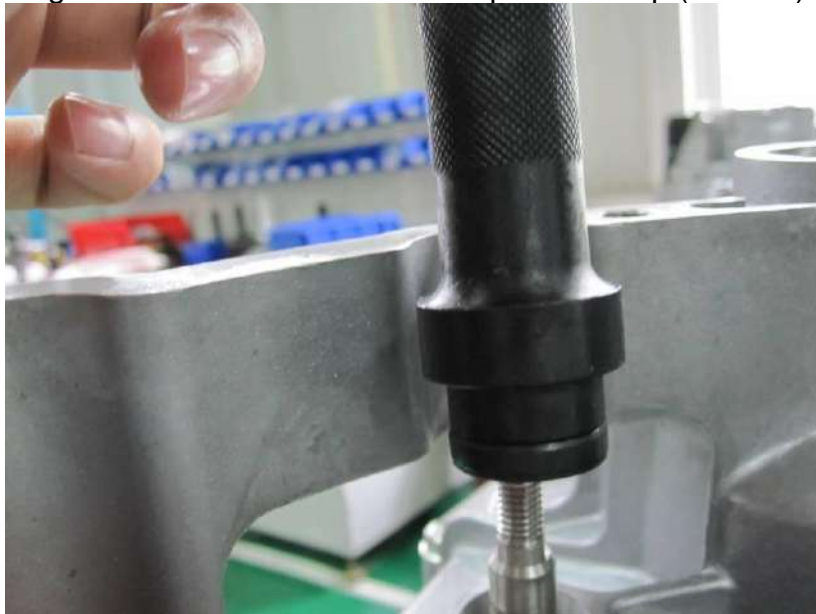

Fig. 4-6: Place special stamp (480125) with seal over the selector shaft

	文件 DOCUMENT	编号 Number	D-ASS-224-00-e
		页号 Page	43 / 90



- Fig. 4-7: Hammer down special stamp (480125) with seal till no further is possible
- Remove the stamp while rotating, otherwise there is the possibility the seal comes back out with the stamp
 - Remount the lever selector shaft with new washer (482584) and nut (481329).
 - Tighten the nut with $14.5\text{Nm} \pm 1.5\text{Nm}$
 - Refit transmission in vehicle
 - Refill transmission according instruction (see 2.1)

2.6.2.5. Replacing primary cover

When:

In case of leakage on primary cover

How:

- Drain approx. 1litre of oil out of the transmission (see replacing oil filter)
- The transmission does not need to be removed from the vehicle but may be lowered together with the engine for easier access
- Loosen the three bolts and clips which are fixing the primary cover to the housing.
- Use a screwdriver to lift out the primary cover. Use some cloth to protect the transmission from damage (see Fig. 5-1)
- Remove the big O-ring and discard both O-ring and primary cover
- Take a new O-ring and assemble it
- Replace a new primary cover and fix clips and bolts with a torque of $9.5\text{Nm} \pm 2.5\text{Nm}$
- Refill transmission with 1litre of oil

	文件 DOCUMENT	编号 Number	D-ASS-224-00-e
		页号 Page	44 / 90



Fig. 5-1: Remove primary cover from transmission

2.6.2.6. Replacing oil pump

When:

In case the transmission pressure is too low or the driver feel shocks or abnormal driving behaviour, two main parts can cause this problem, hydraulic unit or oil pump. Also analyze the P-code and follow actions on specific P-code to replace either hydraulic unit or pump. In most of cases it is unclear which one the problem causes so one by one can be replaced and see if the problem is solved.

How:

- Follow the steps to remove the primary cover
- Remove the 6 pump bolts and place special tool (480141) (see Fig. 6-1)
- Pull the sliding part of the tool a few times to lift out the pump (see Fig. 6-2).
- Replace the pump with a new one. Make sure you put 2 new O-rings and 1 plastic snap ring on the new pump. Do not take out the Belle-ville washer and leave it in its correct position which is biggest diameter facing the pump (see Fig. 6-3)
- Put the 6 screws back and tighten with (10Nm +/- 1Nm)
- Follow the steps to close back the primary cover, no need to take new primary cover O-ring and primary cover

	文件 DOCUMENT	编号 Number	D-ASS-224-00-e
		页号 Page	45 / 90



Fig. 6-1: Remove six bolts and place tool (480141)



Fig. 6-2: Pull the tool to lift out pump

	文件 DOCUMENT	编号 Number	D-ASS-224-00-e
		页号 Page	46 / 90

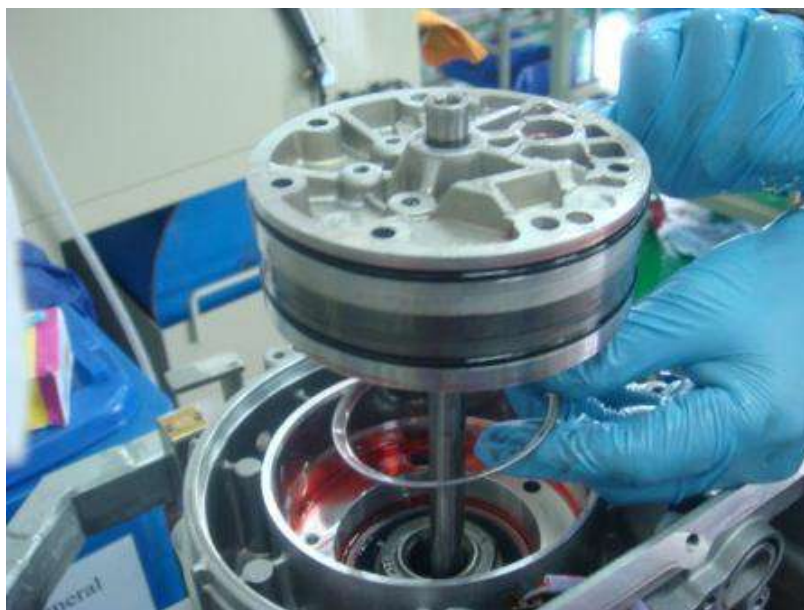

Fig. 6-3: Belle-ville washer

2.6.2.7. Replacing primary ball bearing

When:

In case of worn out primary ball bearing. A worn out primary ball bearing gives a big noise for which the frequency is dependent on engine speed. This can be easily checked by driving at a constant speed and shift to sport mode. The engine rpm will go up and if the noise frequency also goes up, then there is a big possibility that you have a worn out primary ball bearing.

How:

- Follow the steps to remove the oil pump
- Remove Belle-ville washer
- Mark the position of the primary nut on the shaft (see Fig. 7-1)
- Using an air impact wrench with a torque capacity of +/-300Nm, remove the primary nut
- Lever out the seal of the primary ball bearing using a small screwdriver (see Fig. 7-2)
- Place the special tool primary plug (480139) (see Fig. 7-3)
- Assemble the bearing puller (480136) underneath the exterior ring of the primary bearing (see Fig. 7-4)
- Remove primary bearing by tightening the centre bolt of the bearing puller (see Fig. 7-5)
- Discard primary bearing, clean primary shaft, clean sealant from threads in oil pump drive shaft and clean oil pump housing (see Fig. 7-6)
- Place a new bearing on the primary shaft and use special stamp tool (480137 + 480126) to put bearing in. Use rubber hammer and hit until no further possible (see Fig. 7-7)
- Fit and tighten nut using an air impact wrench for sufficient duration until the marks on nut and shaft are in line(+/-5°)
- Place back the Belle-ville washer, biggest diameter facing the pump
- Follow the steps of putting back the oil pump

	文件 DOCUMENT	编号 Number	D-ASS-224-00-e
		页号 Page	47 / 90



Fig. 7-1: Mark primary nut and shaft



Fig. 7-2: Lever out seal from primary bearing

	文件 DOCUMENT	编号 Number	D-ASS-224-00-e
		页号 Page	48 / 90



Fig. 7-3: Put special tool on shaft (primary plug 480139)



Fig. 7-4: Assemble bearing puller (480136)

	文件 DOCUMENT	编号 Number	D-ASS-224-00-e
		页号 Page	49 / 90

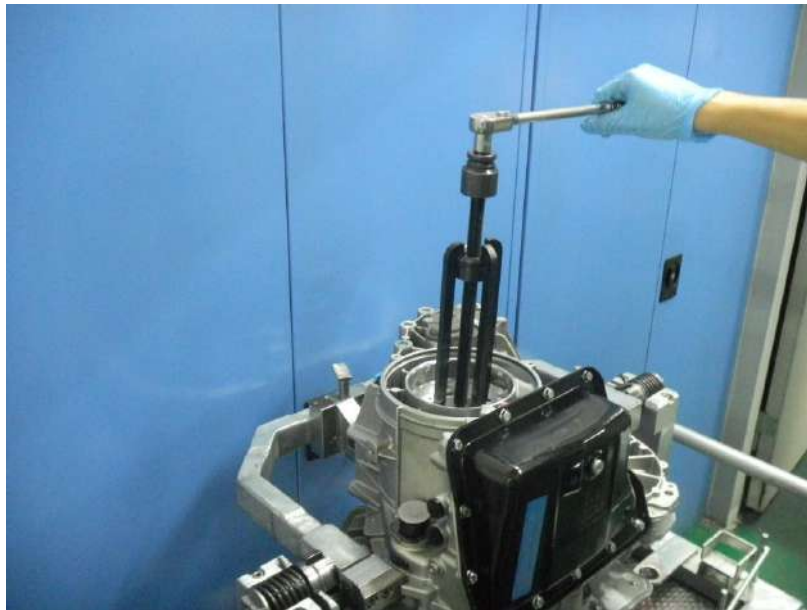

Fig. 7-5: Tighten centre bolt of bearing puller to lift out bearing



Fig. 7-6: Remove primary bearing

	文件 DOCUMENT	编号 Number	D-ASS-224-00-e
		页号 Page	50 / 90



Fig. 7-7: Fit new primary ball bearing

2.6.2.8. Replacing secondary cover

When:

In case of secondary cover damage or leak.

How:

- The transmission does not need to be removed from the vehicle but may be lowered together with the engine for easier access
- Loosen the four screws and discard screws
- Take off secondary cover, remove the small and bigger O-ring and the center sealing ring
- In case of damaged cover, take a new secondary cover
- Replace new O-rings and sealing ring
- Remove the glue (glue from the sealant screws) gently from the transmission housing
- Tighten the secondary cover with 4 new screws, torque 9.5Nm +/- 0.95Nm



Fig.1 : Take off secondary cover bolt

	文件 DOCUMENT	编号 Number	D-ASS-224-00-e
		页号 Page	51 / 90



Fig.2 : remove secondary cover

2.6.2.9. Replacing oil pan

When:

In case of oil pan damage and or leak.

How:

- Drain the oil by removing the oil drain plug (see Fig. 9-1)
- Let all oil drip out, discard old drain plug
- Remove oil pan by unscrewing all 13 screws from the oil pan (see Fig. 9-2)
- Discard the oil pan gasket and oil pan
- Take new oil pan and gasket
- Fix oil pan with new gasket by tightening the screws according to Fig. 9-3 with 9.5Nm +/- 1Nm
- Refill transmission according instruction (see 2.1).



Fig. 9-1 Remove oil drain plug

	文件 DOCUMENT	编号 Number	D-ASS-224-00-e
		页号 Page	52 / 90



Fig. 9-2 Removing the oil pan

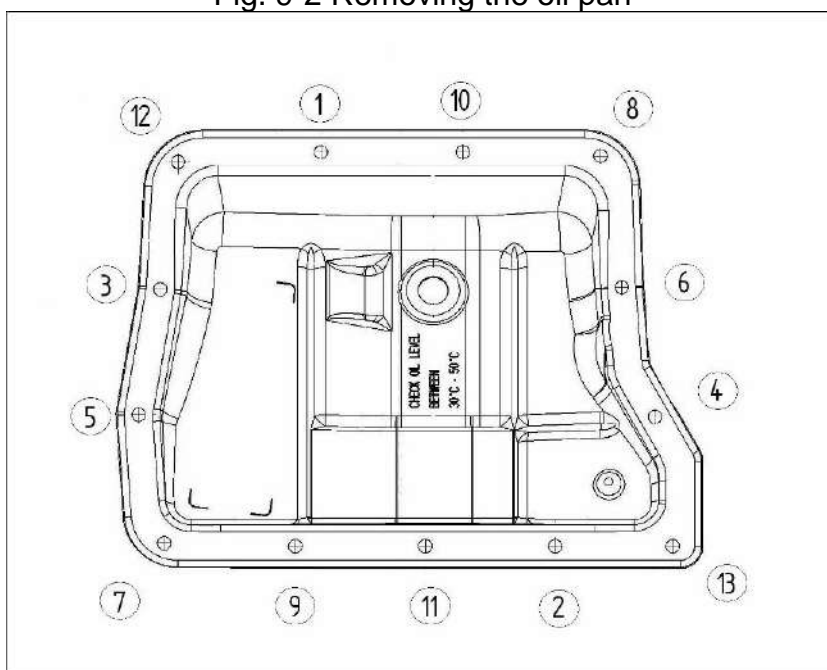

Fig. 9-3: Bolts sequence

2.6.2.10. Replacing oil filter

When:

Oil filter need to be replaced at least every 60000 km. This service interval can be advanced to match with the standard service of the vehicle.

How:

- Drain the oil by removing the oil drain plug (see Fig. 9-1)
- Let all oil drip out, discard old drain plug
- Refit new drain plug and tighten with 11Nm +/-1Nm
- Remove oil pan by unscrewing all 13 screws from the oil pan (see Fig. 9-2)

	文件 DOCUMENT	编号 Number	D-ASS-224-00-e
		页号 Page	53 / 90

- Discard the oil pan gasket
- Remove the oil filter by pulling it gently, discard oil filter
- Take new filter with O-ring and lubricate the O-ring with clean ESSO EZL799(A) (see Fig. 10-1)
- Press in gently the new oil filter and position correctly (centre hole of oil filter should match centre bolt of hydraulic unit) (see Fig. 10-2)
- Clean magnet and surface of oil pan and place a new oil pan gasket
- Place oil pan with new gasket in place and tighten the 13 screws according to Fig. 9-3 with 9.5Nm +/- 1Nm
- Refill transmission according instruction (see 2.1)



Fig. 10-1: Lubricate the O-ring



Fig. 10-2: Fix oil filter in position

2.6.2.11. Replacing drive mode sensor

When:

	文件 DOCUMENT	编号 Number	D-ASS-224-00-e
		页号 Page	54 / 90

In case of faulty drive mode sensor. Dedicated error code should indicate problem with drive mode sensor. Replace drive mode sensor when error code action indicates it.

How:

- Follow steps to remove oil filter
- Unscrew the 2 bolts of the drive mode sensor (see Fig. 11-1)
- Be careful to remove the drive mode sensor from the hydraulic unit because the back of the sensor is locked with a pin in the metal slide of the hydraulic unit. Push the sensor down to remove the pin from the metal slide (see Fig. 11-2)
- Use small screwdriver to unlock the gray lock button of the drive mode sensor connector by pushing it forward (see Fig. 11-3). Now it is possible to disconnect the drive mode sensor from the main cable harness
- Take a new drive mode sensor, connect the connector to the main cable harness and lock it by pushing the gray lock button
- Place drive mode sensor against the metal slide, with the pin on the back of the sensor locked in the dedicated space on the slide (see Fig. 11-4)
- Align the drive mode sensor so the screw holes lign up
- Tighten the 2 screws with 9.5Nm +/- 0.95Nm
- Follow the steps to place back the oil filter

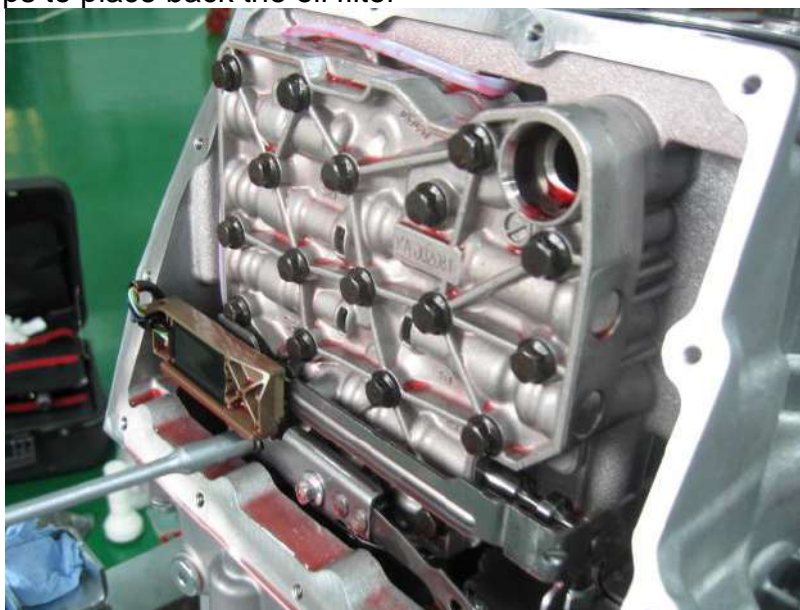

Fig. 11-1: Loosen drive mode sensor bolts

	文件 DOCUMENT	编号 Number	D-ASS-224-00-e
		页号 Page	55 / 90

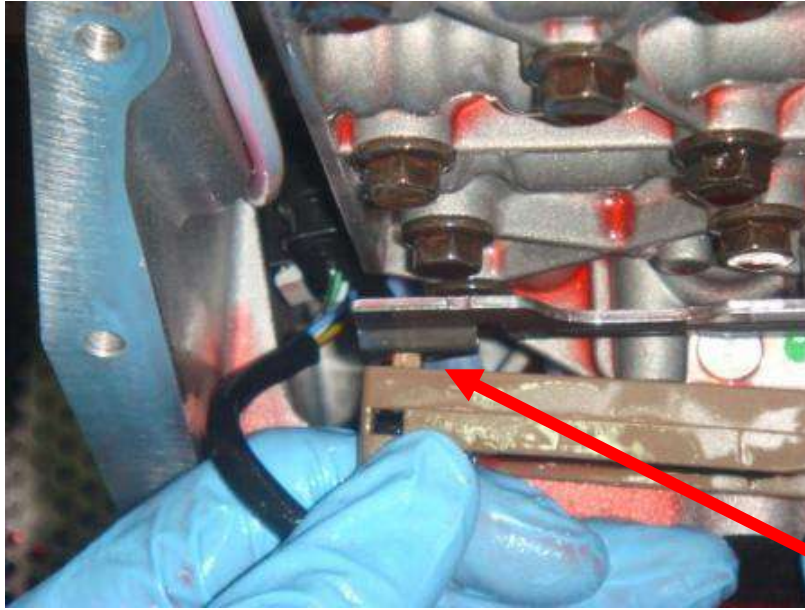

Fig. 11-2: Push sensor down to remove pin from metal slide

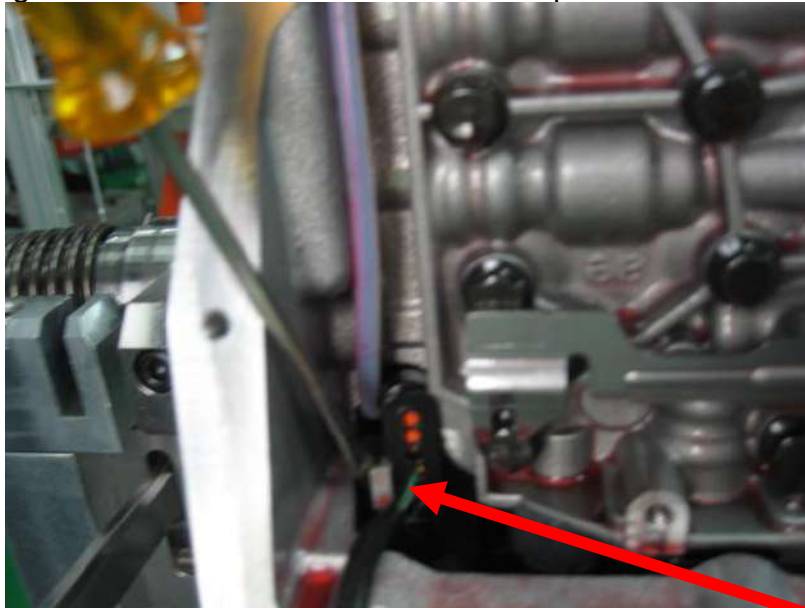

Fig. 11-3: Unlock drive mode sensor connector

	文件 DOCUMENT	编号 Number	D-ASS-224-00-e
		页号 Page	56 / 90



Fig. 11-4: Pin locked in dedicated space of the metal slide

2.6.2.12. Replacing hydraulic unit

When:

In case there is a problem with the transmission pressure or the driver feel shocks or abnormal driving behaviour, two main parts can cause this problem, hydraulic unit or oil pump. Also analyze the P-code and follow actions on specific P-code to replace either hydraulic unit or pump. In most of cases it is unclear which one the problem causes so one by one can be replaced and see if the problem is solved.

How:

- Follow steps to remove the drive mode sensor
- Follow the sequence on Fig. 12-1 in reverse order 20-19-18-17-16-15-14-13-12-11-10-9-8-7-6-5-4-3-2-1 to unscrew all hydraulic unit bolts
- Take out the hydraulic unit and disconnect the 4 connectors. A small screwdriver can be used carefully to disconnect easier (see Fig. 12-2 and 12-3)
- Take a new hydraulic unit and connect the 4 connectors. No mistake can be made due to the length of the cables
- Place the hydraulic unit in place, there is a guiding pin on the back of the hydraulic unit that fits into a dedicated hole (see Fig. 12-4)
- Make sure that the metal slide fits in the pin of the rooster cam plate (see Fig. 12-5)
- Place the center screw and hand tighten it
- Place the special alignment tool (480142) on the top left screw hole and screw it in (see Fig. 12-6)
- Push the speed sensor cable behind the upper left corner of the hydraulic unit (see Fig. 12-6)
- Place all screws of hydraulic unit, except the upper left one and tighten with 11Nm +/- 1Nm in sequence 1-2-3-4-5-6-7-8-9-10-11-12-13-14-15-16-17-18-19-20 on Fig. 11-1 When arriving at the upper left one, take out special tool and replace with screw and continue until screw 20.
- Follow steps to place back the drive mode sensor

	文件 DOCUMENT	编号 Number	D-ASS-224-00-e
		页号 Page	57 / 90



Fig. 12-1: Order of the bolts

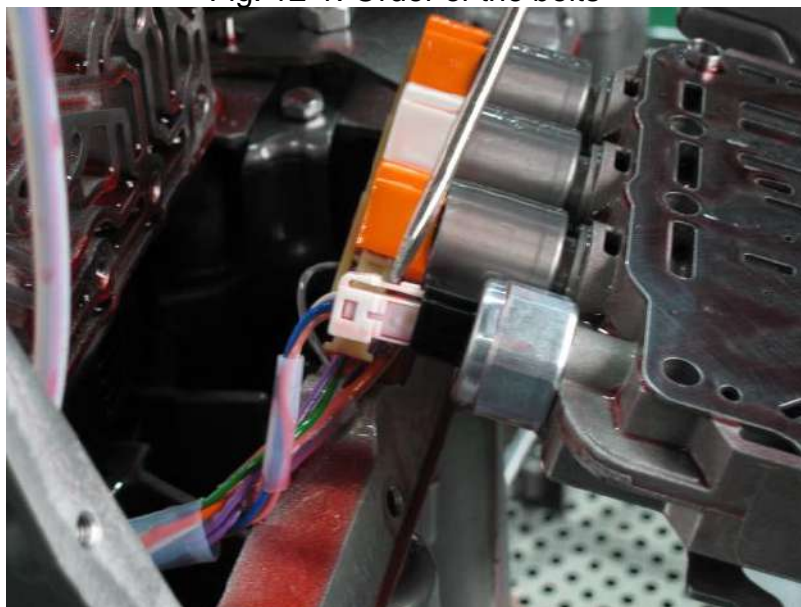

Fig. 12-2: Use a screwdriver to separate the 4 connectors

	文件 DOCUMENT	编号 Number	D-ASS-224-00-e
		页号 Page	58 / 90

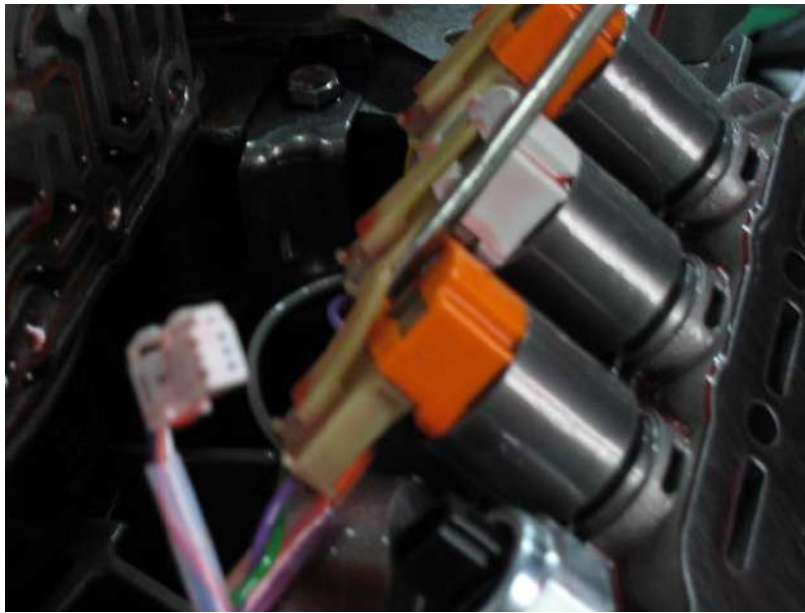

Fig. 12-3: Use a screwdriver to separate the 4 connectors

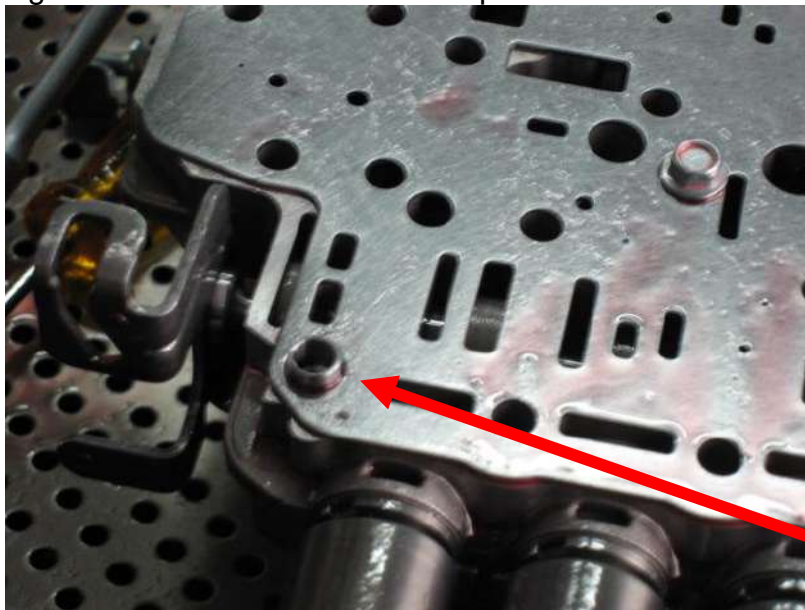

Fig. 12-4: Guiding pin on the back of hydraulic unit

	文件 DOCUMENT	编号 Number	D-ASS-224-00-e
		页号 Page	59 / 90

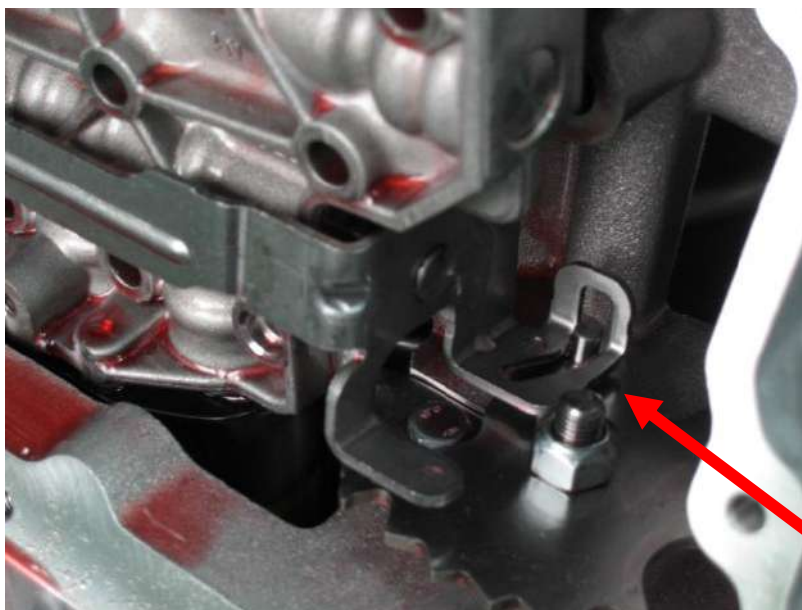

Fig. 12-5: Pin of rooster cam needs to fit in metal slide



Fig. 12-6: Special alignment (480142) tool for hydr. unit

2.6.2.13. Replacing output speed sensor and bracket

When:

In case indicated by actions from the error code list

How:

- Follow steps to remove the hydraulic unit
- Loosen bolt bracket output speedsensor and discard bolt (see Fig. 13-1)
- Slide out the bracket, there is a dedicated sleeve in the selector shaft! (see Fig. 13-2)
- Disconnect cable from speedsensor with long flat nose pliers (see Fig. 13-3)
- Remove sensor from bracket by unscrewing bolt
- Discard sensor and/or bracket

	文件 DOCUMENT	编号 Number	D-ASS-224-00-e
		页号 Page	60 / 90

- Take new sensor and/or bracket and mount together with bolt (Torque 8.5Nm +/- 2Nm)
- Connect wire and slide bracket back in the selector shaft
- Take a new bolt bracket output speedsensor and tighten with 9.5Nm +/- 0.95Nm
- Follow steps to place back the hydraulic unit



Fig. 13-1: Loosen bolt bracket output speed sensor



Fig. 13-2: Bracket output speed sensor

	文件 DOCUMENT	编号 Number	D-ASS-224-00-e
		页号 Page	61 / 90

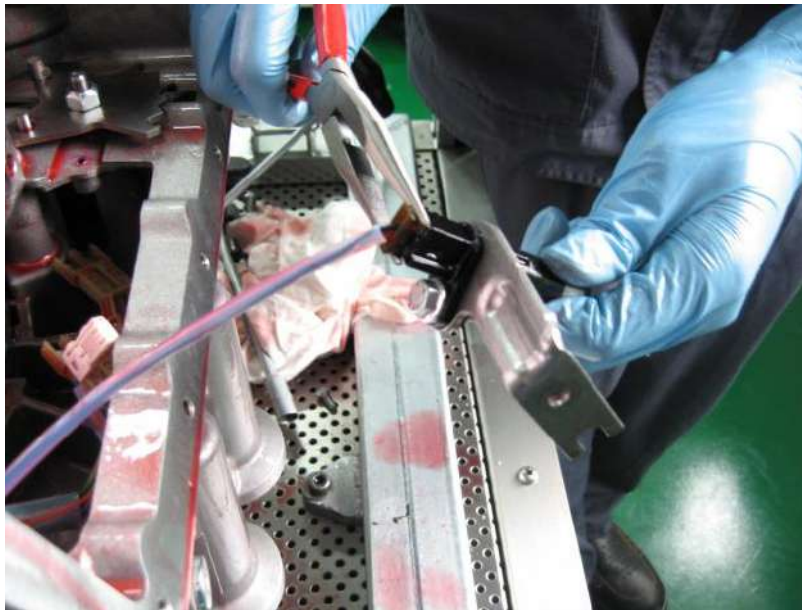

Fig. 13-3: Use long flat nose pliers to disconnect

2.6.2.14. Replacing primary speed sensor

When:

In case indicated by actions from the error code list

How:

- Follow steps to remove the primary cover
- Loosen bolt of speedsensor and take out sensor (see Fig. 14-1)
- Disconnect wire and discard sensor
- Take new sensor and screw down with 8.5Nm +/- 2Nm
- Connect wire to sensor
- Follow steps to put back primary cover

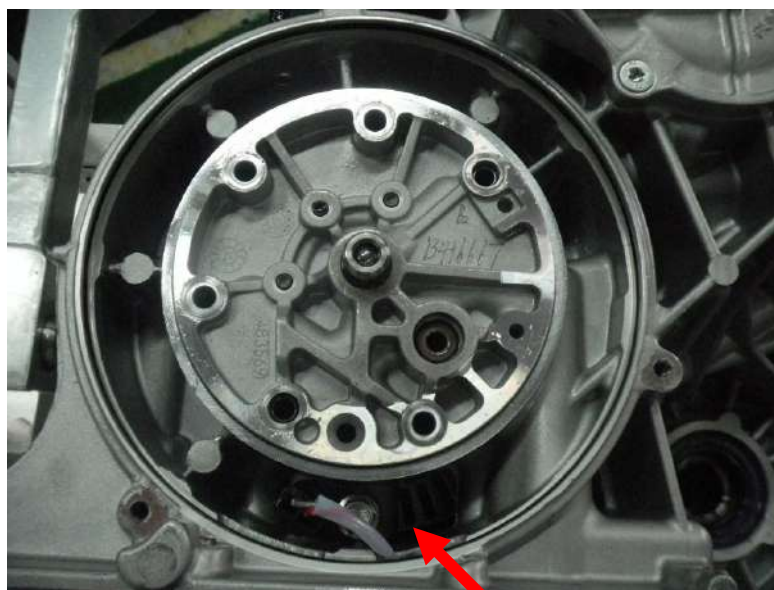

Fig. 14-1: Primary pulley speed sensor

	文件 DOCUMENT	编号 Number	D-ASS-224-00-e
		页号 Page	62 / 90

2.6.2.15. Replacing main connector and internal cable harness

When:

In case indicated by actions from the error code list

How:

- Follow steps to remove hydraulic unit
- Disconnect output speed sensor
- Disconnect the car cable harness connector from the main connector on the transmission
- Remove the clip with pliers and push the main connector into the transmission (see Fig. 15-1, 15-2)
- The drive mode sensor connector is clipped on the transmission, loosen that one first (see Fig. 15-3)
- Remove the complete cable harness from the transmission and discard
- Take new cable harness and put into transmission
- The main connector has a sleeve which should fit over the securing key on Fig. 15-4, 15-5
- The use of a 45deg angled nose pliers can be helpful to fit in the main connector
- Push clip back on main connector
- Push drive mode sensor connector on the transmission (see Fig. 15-6)
- Connect the output speed sensor
- Follow steps to place back the hydraulic unit



Fig. 15-1: Remove the clip from the main connector

	文件 DOCUMENT	编号 Number	D-ASS-224-00-e
		页号 Page	63 / 90



Fig. 15-2: Push main connector into the transmission



Fig. 15-3: Remove drive mode sensor connector from transmission

	文件 DOCUMENT	编号 Number	D-ASS-224-00-e
		页号 Page	64 / 90

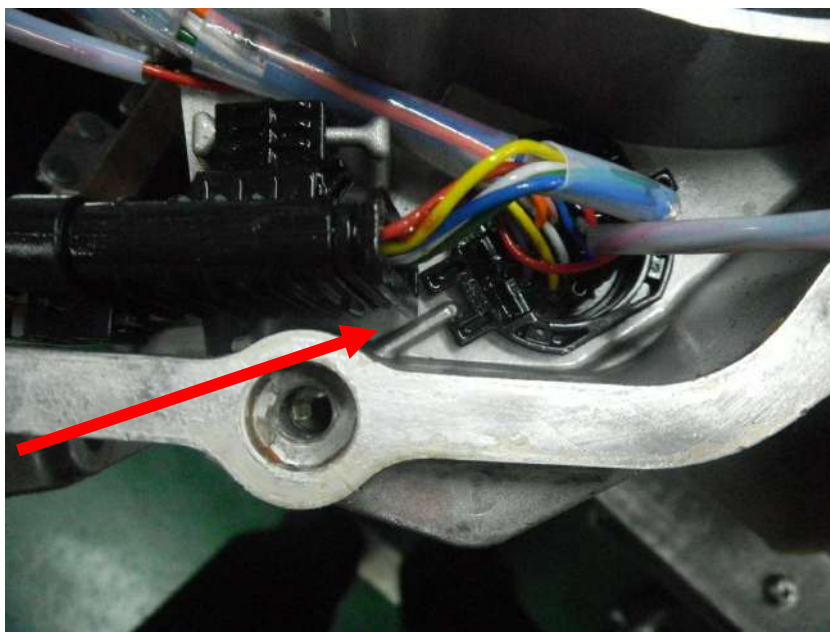

Fig. 15-4: Securing key

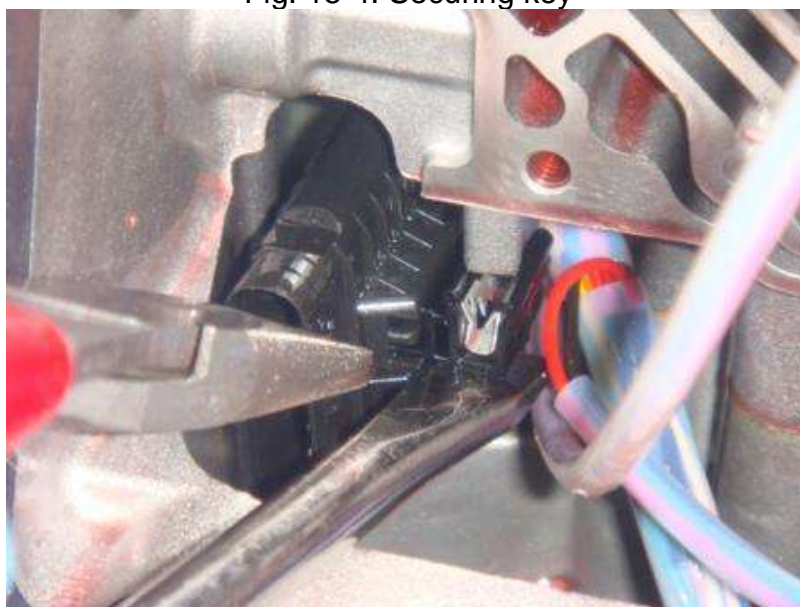

Fig. 15-6: Push drive mode sensor connector on the transmission

2.6.2.16. Replacing the breather pipe

When:

In case of breather pipe damage which can cause dirt or water to enter the transmission.

How:

- Possibly the airbox, the battery and top bracket needs to be removed to have a clear access to the breather pipe.
- Remove the clip on top of the breather pipe which connects it to the transmission housing.
- Remove the breather pipe with pliers. Connect the pliers at the root (Aluminum piece of the breather pipe) and twist and pull to take it out.

	文件 DOCUMENT	编号 Number	D-ASS-224-00-e
		页号 Page	65 / 90

- Place the new breather pipe (483114) into the special tool (480140), see Fig. 16-1. Put a little amount of Vaseline on the Aluminum piece of the breather pipe.
- Place tool and breather pipe onto the transmission housing so the pipe runs about parallel with the transmission, Fig. 16-2. Hammer down gently the breather pipe into the transmission house till the end by using a plastic hammer on top of the special tool.
- Put the plastic clip (482253) around the pipe.
- Put the pins of the plastic clip thru the hole of the metal clip (481456).
- Push the metal clip firmly (till the end) onto the ridge of the transmission house.
- Slide the breather cap (483117) complete over the top of the breather pipe. Fig. 16-3
- Replace airbox and battery if needed.



Fig. 16-1: Place the new breather pipe into the assembly tool



Fig. 16-2: Hammer down the tool till the end with plastic hammer

	文件 DOCUMENT	编号 Number	D-ASS-224-00-e
		页号 Page	66 / 90

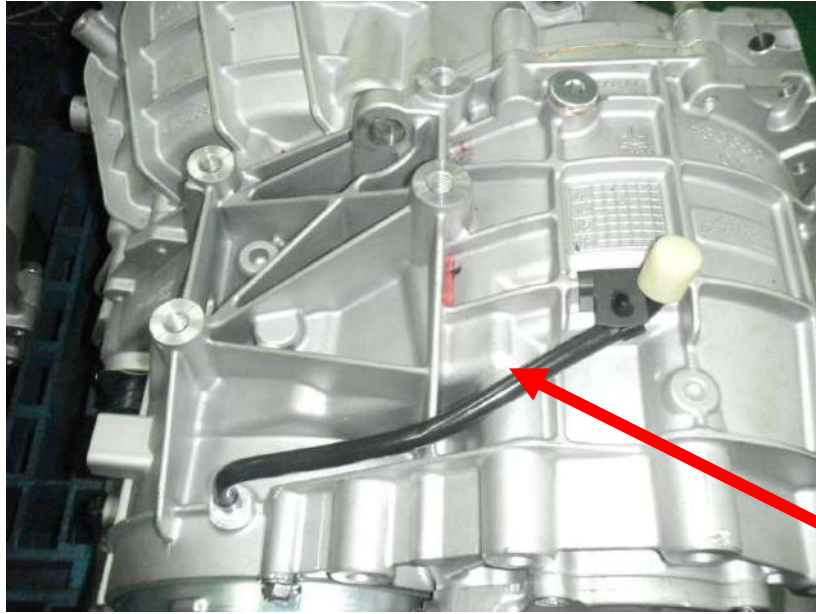

Fig. 16-3: Place the clips and cap

	文件 DOCUMENT	编号 Number	D-ASS-224-00-e
		页号 Page	67 / 90

2.7. Checklist of the electronic components in the transmission

In most cases the error codes from the TCU will indicate if there is something wrong with one of the electronic components inside the transmission.

The following resistor measurements can be performed to check if the electronic components are faulty or not.

All measurements indicated here are performed on the main harness connector of the transmission.

Drive Mode Sensor

Check the internal resistance between the different DMS pins.

DMS_GND = pin 6

DMS_A= pin 13

DMS_B= pin 14

DMS_C= pin 15

DMS_D= pin 16

DMS_Supply= pin 9

	DMS_Supply	DMS_A	DMS_B	DMS_C	DMS_D
DMS_Supply	X	17.2MOhm	17.2Mohm	17.2Mohm	17.2Mohm
DMS_A	17.2Mohm	X	9Kohm	9Kohm	9Kohm
DMS_B	17.2Mohm	9Kohm	X	9Kohm	9Kohm
DMS_C	17.2Mohm	9Kohm	9Kohm	X	9Kohm
DMS_D	17.2Mohm	9Kohm	9Kohm	9Kohm	X
DMS_GND		4.5Kohm	4.5Kohm	4.5Kohm	4.5Kohm

Oil Temp Sensor

Check the internal resistance of the Temp. sensor.

	文件 DOCUMENT	编号 Number	D-ASS-224-00-e
		页号 Page	68 / 90

Measure between pin 5 and pin 7.

When temp. between 20°C and 40°C, we need to measure a resistance between 942 Ohm and 1121 Ohm.

Speed Sensor

This is a complicated 'Two Wire' component with no easy way of checking the correct way of working.

Between pin 9 and pin 11, we need to measure a resistance of app. 24,3 MOhm.

Between pin 9 and pin 12, we need to measure a resistance of app. 24,3 MOhm.

NOTE: this method will not guarantee the correct function of the speed sensor.

Oil Pressure Sensor

Between pin 7 and pin 10, we need to measure a resistance of app. 44,3 KOhm.

Clutch Pressure Regulator

Between pin 1 and 4, we need to measure a resistance of app. 5,2 Ohm.

Primary Pressure Regulator

Between pin 1 and 3, we need to measure a resistance of app. 5,2 Ohm.

Secondary Pressure Regulator

Between pin 1 and 2, we need to measure a resistance of app. 5,2 Ohm.

TCU

No checking possible.

Remark: Ranges of resistor values can differ in function of the accuracy of the measuring equipment.

	文件 DOCUMENT	编号 Number	D-ASS-224-00-e
		页号 Page	69 / 90

3. Trouble shooting guide

3.1. Leaks

Fault	Action
Leak from gearbox oil pan gasket	Ensure oil pan bolts are correctly tightened Replace oil pan gasket Replace drain plug Replace oil pan complete
Leak from gearbox drain plug	Ensure plug is correctly tightened Replace drain plug Replace oil pan complete
Leak from primary cover	Ensure that cover is correctly tightened Replace O ring Replace primary cover
Leak from secondary cover	Ensure that cover is correctly tightened Replace cover O-rings Replace secondary cover complete
Leak from selector shaft lever	Replace selector shaft lever seal
Leak from input shaft	Replace input shaft seal
Leak from differential oil seal(s)	Replace differential oil seals
Leak from oil cooler pipe connections	Ensure that pipes are correctly tightened Replace pipe to oil cooler connection sealing rings Replace pipes

3.2. Noise problems

	文件 DOCUMENT	编号 Number	D-ASS-224-00-e
		页号 Page	70 / 90

3.2.1. Secondary gear sound

Sound description:

Sound best heard with a vehicle speed between 60kph to 90kph while slowly accelerating. When releasing the gas pedal, sound normally is getting smaller, give throttle again, the sound comes back.

The sound is like a whistle sound. The frequency of the sound goes up with vehicle speed.

This is a normal sound from the CVT which comes from the secondary gear running into the pinion shaft gear.

3.2.2. Reverse sound

Sound description:

When standing still and shift to Reverse, a small whistle sound can be heard.

When releasing brake and start driving in Reverse the sound gets bigger and turns into a whining sound.

This is a normal sound from the planetary gear set inside the transmission.

3.2.3. Low speed gear sound

Sound description:

When the vehicle speed is around 40kph, release gas pedal, while car is slowing down, a whistle sound can be heard. This whistle sound is much lower in frequency than 3.2.1. And is much more difficult to hear.

This is a normal sound from the pinion and crown wheel.

3.2.4. Primary ball bearing noise and inside bearing noise

Primary Ball bearing noise:

Sound description:

During driving in D, from low speeds on the car makes a noise like “wengweng”. The frequency and volume of the noise gets higher with engine speed!

The noise goes up with engine speed and **not** with vehicle speed!

How to check and repair:

1. Drive in D at a constant speed, fix gas pedal and vehicle speed around 60kph. Shift to S (Sport) mode: the engine speed will go up about 500rpm within 1 or 2 seconds while keeping the same vehicle speed. If the sound also goes up (that means it goes up with engine speed and not with vehicle speed), than there is a big chance the primary ball bearing is damaged.

	文件 DOCUMENT	编号 Number	D-ASS-224-00-e
		页号 Page	71 / 90

Replace Primary ball bearing according 2.6.2.7.

2. Drive in manual mode 4th gear and fix your gas pedal so you have a vehicle speed of around 60kph.
Shift to 3rd gear while keeping vehicle speed 60kph. The engine speed will go up about 800rpm. If the sound also goes up (that means it goes up with engine speed and not with vehicle speed), than there is a big chance the primary ball bearing is damaged.
Replace Primary ball bearing according 2.6.2.7.

Transmission inside bearing noise:

Sound description:

During driving in D, from low speeds on the car makes a noise like “wengweng”.

How to check and repair:

According the primary ball bearing noise, if the frequency and volume of the noise does **not** go up or down with related engine speed but the sound is related to vehicle speed then the noise could come from transmission inside bearings.

These cannot be replaced and so complete transmission needs to be replaced.

NOTE: Noise problems are very hard to evaluate so before to decide to replace a part of the transmission or change the complete transmission, be sure that the noise is actually coming from the transmission. Check or replace other parts of the car first which are easier to replace.

Use following chart to help to locate the origin of the noise:

	文件 DOCUMENT	编号 Number	D-ASS-224-00-e
		页号 Page	72 / 90

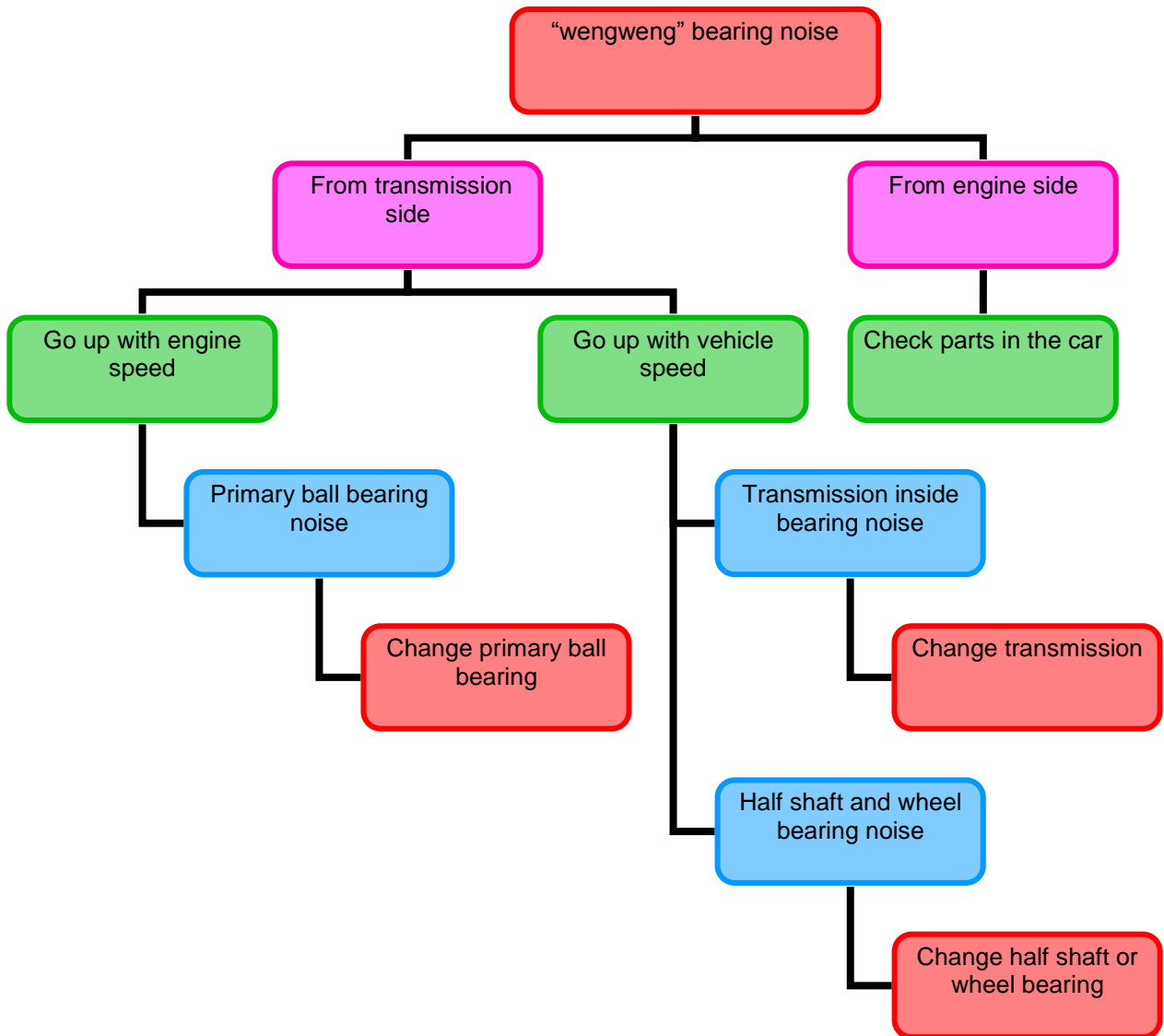

3.2.5. Noise due to water or contaminated oil inside transmission

Sound description:

Car standing still, brake and shift to D or R. As soon as you release the brake a „gegege“ sound can be heard. This can be heard from the first mm the car is moving!

From creeping speed (10kph) by giving throttle to accelerate a „zhi---“ sound can be heard between 10kph to 40kph.

In the beginning stage of water contamination it is possible you only hear the „gegege“ sound and not yet the „zhi---“ sound.

Some cars when taking off can have shocks also, depending on the level of contamination.

How to check and repair:

Drain the oil and remove oil pan and primary cover:

	文件 DOCUMENT	编号 Number	D-ASS-224-00-e
		页号 Page	73 / 90



If the inside of primary cover and oil pan shows white stuff inside, than it is fully clear the transmission has been contaminated with water or other oil or liquid.

Drain the oil as much as possible and discard oil filter.

Place new oil filter and re-fill the transmission according 2.1.

Drive the car for about 5 min at different speeds and accelerations.

Drain the oil and refill again. (Do this 2 or 3 times with driving the car in between until the noise disappears).

The “gegege” sound should disappear and the “zhi---“ sound as well.

The “zhi---“ sound you can make disappear with heating up the clutch by doing stall test: shift to D with foot on brake and apply throttle”

While doing the stall test you can get fault code P2787 (clutch temperature too high)

This is just a self protection of the transmission against over-heating of the clutch. The fault code will disappear automatically and you can perform the stall test again until the “zhi---“ sound gets better or disappears.

If the contamination was too big you will not be able to remove the sound and shocks. In that case the transmission needs to be replaced.

3.2.6. Noise in N or P

1. Frequency and volume of noise goes up with engine speed
Try to find out if the noise comes from engine side or transmission side
If engine side, check parts related to engine
If transmission side, the only part you can check is the pump.
Replace pump to check if the noise is gone.
If noise does not disappear by replacing the pump then either input shaft needle bearing or planetary gear set can be the source of the noise. In this case the transmission needs to be replaced.
2. Frequency and volume of noise does not go up with engine speed
The noise should come from other parts of the car

Use following chart to help to locate the origin of the noise:

	文件 DOCUMENT	编号 Number	D-ASS-224-00-e
		页号 Page	74 / 90

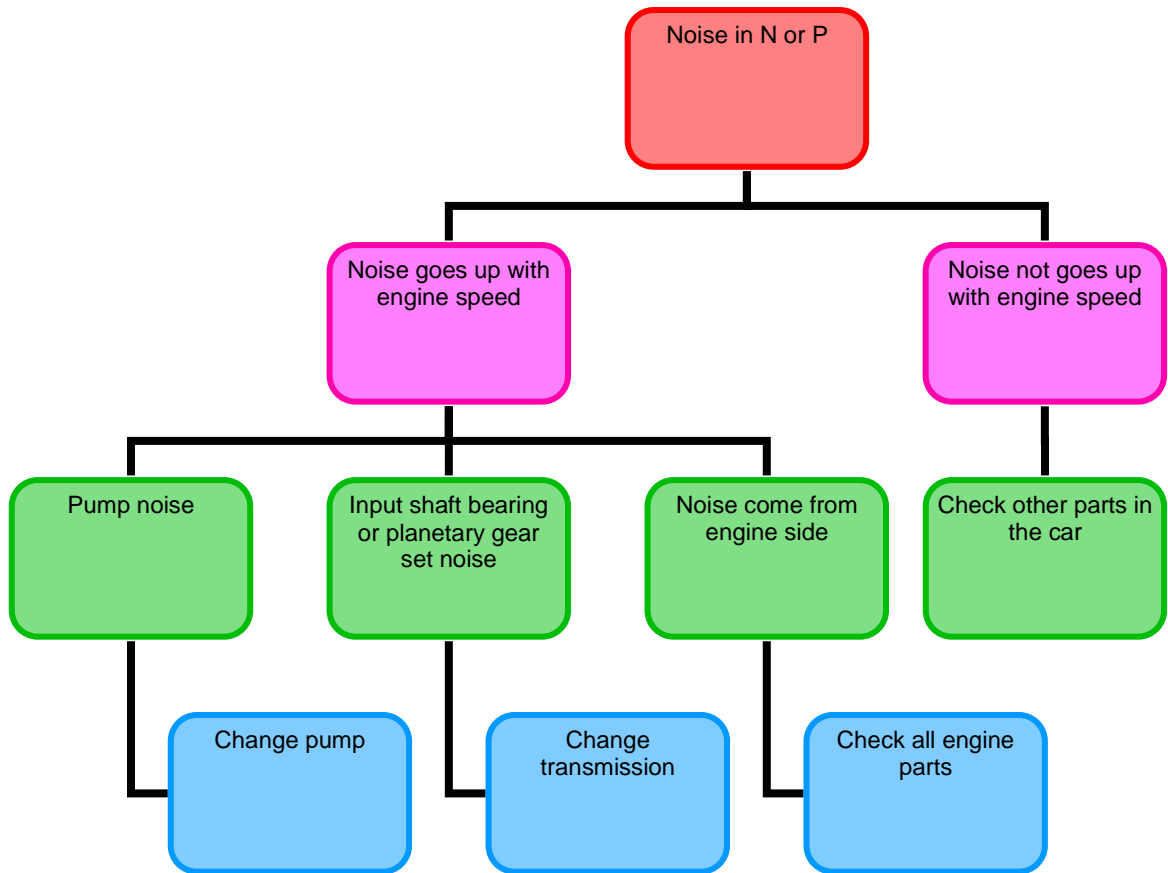

NOTE: Noise problems are very hard to evaluate so before to decide to replace a part of the transmission or change the complete transmission, be sure that the noise is actually coming from the transmission. Check or replace other parts of the car first which are easier to replace.

	文件 DOCUMENT	编号 Number	D-ASS-224-00-e
		页号 Page	75 / 90

3.3. Shocks and no creep problems

3.3.1. Shocks

Problem description:

During driving in D the car shows small vibrations in speed or small shocks can be felt.

Check and repair:

There could be many possibilities for this problem:

1. Clutch adaptation not fully finished: check procedure 1.6.
2. Water or contaminated oil inside transmission: check 3.2.5.
3. Primary speed sensor: replace by instruction 2.6.2.14.
4. Hydraulic unit problem: replace by instruction 2.6.2.12. and redo clutch adaptation procedure 1.6
5. Secondary speed sensor: replace by instruction 2.6.2.13.
6. If still has the problem after trying 1. to 5. please contact After Sales team

3.3.2. No creep

Problem description:

Shift to D, release brake, the car does not move. Give throttle and the car start moving with or without shock from about 2000rpm.

Check and repair:

1. Check if there is a fault code active: check according 3.4.
2. If the problem happens normally in cold condition: redo and check clutch adaptation 1.6.
3. Brake signal problem: if brake is not applied but brake signal is activated (see with tester tool or MLT). Check brake switch and car cable harness.
4. Hydraulic unit problem: replace hydraulic unit by instruction 2.6.2.12. and redo clutch adaptation procedure 1.6
5. If still has the problem after trying 1. to 4. please contact After Sales team

	文件 DOCUMENT	编号 Number	D-ASS-224-00-e
		页号 Page	76 / 90

3.4. P-codes and actions

General remark:

Whenever there is an error (DTC) detected by the transmission electronics (TCU), the warning lamp on the dashboard will be activated or flashing.

When reading out the DTCs with the tester tool and a P-code is found, first check if this P-code is a sporadic fault, that did not occur in the last driving cycle (Should be indicated with an „H“ from History). If so, just delete the FC and check if it does not come back. If not a sporadic fault, but currently active (Should be indicated with a „C“ from Currently), follow the action steps described below for each error code. **Always check if the latest software is present. If not flash to the latest TCU software and check the faultcodes again.**

Do not perform all „Man actions“, stop the sequence of actions whenever the problem is solved.

P0710 Oil temperature sensor fault

Reaction from TCU :

Warning lamp, Substitute transmission oil temperature

Man actions:

- 1、 measure the oil temperature online with tester tool; if the signal value is feasible, just clear the FC and check if it does not come back
- 2、 check wiring (SG, SB, OC), based on this replace either transmission cable harness or vehicle cable harness
- 3、 measure resistance between two pins on transmission connector (20deg = 980 to 1000 Ohm) to see if sensor is defective. If it's defective, skip next step and directly replace transmission cable harness
- 4、 replace TCU by known good one
- 5、 if still has problem, please inform of the Punch in time.

P2765 Primary pulley speed sensor fault

Reaction from TCU :

High side* off, Warning lamp

Man actions:

- 1、 measure the primary speed sensor value online with tester tool; if the signal value is feasible, just clear the FC and check if it does not come back
- 2、 check wiring (SG, SB, OC), based on this replace either transmission cable harness or vehicle cable harness
- 3、 replace TCU by known good one
- 4、 replace speed sensor
- 5、 if still has problem, please inform of the Punch in time.

P0720 Secondary pulley speed sensor fault

Reaction from TCU :

	文件 DOCUMENT	编号 Number	D-ASS-224-00-e
		页号 Page	77 / 90

High side* off, Warning lamp

Man actions:

- 1、measure the secondary speed sensor value online with tester tool; if the signal value is feasible, just clear the FC and check if it does not come back
- 2、check wiring (SG, SB, OC), based on this replace either transmission cable harness or vehicle cable harness
- 3、check the car whether use original tyres or not? If use spare tyres or not original tyre, replace tyres;
- 4、replace speed sensor
- 5、replace TCU by known good one
- 6、if still has problem, please inform of the Punch in time.

P0840 Secondary pressure sensor fault

Reaction from TCU :

High side* off, Warning lamp

Man actions:

- 1、measure the actual and target secondary pressure online with tester tool; if the signal value is feasible, just clear the FC and check if it does not come back。
- 2、check wiring based on the values read out in step one (SG: 0 bar (actual pressure), SB: 60 bar, OC: 60 bar): replace either transmission cable harness or vehicle cable harness
- 3、replace hydraulic unit
- 4、replace TCU by known good one
- 5、if still has problem, please inform of the Punch in time.

P0641 Pressure sensor supply fault

Reaction from TCU :

High side* off, Warning lamp

Man actions:

- 1、measure the 5V supply voltage online with tester tool; if the signal value is feasible, just clear the FC and check if it does not come back。
- 2、measure voltage between pressure sensor supply and pressure sensor ground, based on result you get in step 1
- 3、check wiring (SG, SB, OC), based on this replace either transmission cable harness or vehicle cable harness
- 4、replace TCU by known good one
- 5、replace hydraulic unit
- 6、if still has problem, please inform of the Punch in time.

P0651 DMS and speed sensor supply fault

Reaction from TCU :

High side* off, Warning lamp

Man actions:

	文件 DOCUMENT	编号 Number	D-ASS-224-00-e
		页号 Page	78 / 90

- 1、 measure the 8.4V supply voltage online with tester tool; if the signal value is feasible, just clear the FC and check if it does not come back。
- 2、 measure voltage between pressure sensor supply and pressure sensor ground, based on result you get in step 1
- 3、 check wiring (SG, SB, OC), based on this replace either transmission cable harness or vehicle cable harness
- 4、 replace DMS or speed sensor
- 5、 replace TCU by known good one
- 6、 if still has problem, please inform of the Punch in time.

P0659 High side* SCB

Reaction from TCU :

High side* off, Warning lamp

Man actions:

- 1、 measure the HS voltage , the same voltage level as the battery should be read out . If so, check wiring (check if shortcut between battery + and VHS, transmission connector). This means fix the harness (transmission harness or vehicle harness) . If not (same as battery) but higher than 3.4 V, then exchange the TCU.

P0658 High side* SCG or OC

Reaction from TCU :

High side* off, Warning lamp

Man actions:

- 1、 measure the HS voltage: compare it to the battery voltage. If the battery voltage is ok, and the high side voltage is smaller than 3.4 V, then there is a SG. If the battery voltage is ok, and the high side voltage is higher than 3.4 V, then it's an OC. In both cases, check the harness (transmission harness or vehicle harness), dependant on the type of problem (mention the pin nbs). If, after checking, the harness is ok, change the TCU. If the battery voltage was not ok, then check the battery.

P0702 Watchdog test failed (during init)

Reaction from TCU :

High side* off, Warning lamp

Man actions:

replace TCU

P0962 EDS1* (primary pulley) SCG

Reaction from TCU :

High side* off, Warning lamp

Man actions:

- 1、 measure resistance of EDS1 - should be 5.05 Ohm +- 6%.
- 2、 check wiring (SG), based on this replace either transmission cable harness or vehicle cable harness
- 3、 replace hydraulic unit
- 4、 if still has problem, please inform of the Punch in time.

P0963 EDS1* (primary pulley) SCB

Reaction from TCU :

	文件 DOCUMENT	编号 Number	D-ASS-224-00-e
		页号 Page	79 / 90

High side* off, Warning lamp

Man actions:

- 1、 measure resistance of EDS1
- 2、 check wiring (SB), based on this replace either transmission cable harness or vehicle cable harness
- 3、 replace hydraulic unit
- 4、 if still has problem, please inform of the Punch in time.

P0960 EDS1* (primary pulley) OC

Reaction from TCU :

High side* off, Warning lamp

Man actions:

- 1、 measure resistance of EDS1
- 2、 check wiring (OC), based on this replace either transmission cable harness or vehicle cable harness
- 3、 replace hydraulic unit
- 4、 if still has problem, please inform of the Punch in time.

P0966 EDS2* (secondary pulley) SCG

Reaction from TCU :

High side* off, Warning lamp

Man actions:

- 1、 measure resistance of EDS2
- 2、 check wiring (SG), based on this replace either transmission cable harness or vehicle cable harness
- 3、 replace hydraulic unit
- 4、 if still has problem, please inform of the Punch in time.

P0967 EDS2* (secondary pulley) SCB

Reaction from TCU :

High side* off, Warning lamp

Man actions:

- 1、 measure resistance of EDS2
- 2、 check wiring (SB), based on this replace either transmission cable harness or vehicle cable harness
- 3、 replace hydraulic unit
- 4、 if still has problem, please inform of the Punch in time.

P0964 EDS2* (secondary pulley) OC

Reaction from TCU :

High side* off, Warning lamp

Man actions:

- 1、 measure resistance of EDS2
- 2、 check wiring (OC), based on this replace either transmission cable harness or vehicle cable harness

	文件 DOCUMENT	编号 Number	D-ASS-224-00-e
		页号 Page	80 / 90

- 3、 replace hydraulic unit
- 4、 if still has problem, please inform of the Punch in time.

P0902 EDS3* (clutch) SCG

Reaction from TCU :

High side* off, Warning lamp

Man actions:

- 1、 measure resistance of EDS3
- 2、 check wiring (SG), based on this replace either transmission cable harness or vehicle cable harness
- 3、 replace hydraulic unit
- 4、 if still has problem, please inform of the Punch in time.

P0903 EDS3* (clutch) SCB

Reaction from TCU :

High side* off, Warning lamp

Man actions:

- 1、 measure resistance of EDS3
- 2、 check wiring (SB), based on this replace either transmission cable harness or vehicle cable harness
- 3、 replace hydraulic unit
- 4、 if still has problem, please inform of the Punch in time.

P0900 EDS3* (clutch) OC

Reaction from TCU :

High side* off, Warning lamp

Man actions:

- 1、 measure resistance of EDS3
- 2、 check wiring (OC), based on this replace either transmission cable harness or vehicle cable harness
- 3、 replace hydraulic unit
- 4、 if still has problem, please inform of the Punch in time.

P1768 Backlight SCG

Reaction from TCU :

Warning lamp

Man actions:

- 1、 check the wiring
- 2、 replace TCU

P1769 Backlight SCB or OC

Reaction from TCU :

Warning lamp

Man actions:

- 1、 check the wiring
- 2、 replace TCU

	文件 DOCUMENT	编号 Number	D-ASS-224-00-e
		页号 Page	81 / 90

P0868 Operation readiness time-out

Reaction from TCU :

High side* off, Warning lamp

Man actions:

- 1、 check oil level and oil type
- 2、 replace pump and oil filter
- 3、 replace hydraulic unit
- 4、 if still has problem, please inform of the Punch in time.

P0811 Clutch (forward or reverse) slipping

Reaction from TCU :

Warning lamp, Clutch open

Man actions:

- 1、 measure the clutch pressure and the difference speed online with tester tool; if the signal value is feasible, just clear the FC and check if it does not come back.
- 2、 If it's not feasible (for example 10 bar clutch pressure and a high difference speed), go to the next step.
- 3、 check oil level and oil type
- 4、 replace 2 speed sensors
- 4、 replace hydraulic unit and oil filter
- 5、 if still has problem, please inform of the Punch in time.

P0730 Ratio control fault

Reaction from TCU :

High side* off, Warning lamp

Man actions:

- 1、 check signal from speed sensors with the tester tool, as well as target current and actual current for the primary pressure and target and actual primary pressure itself;
- 2、 depending on previous results, speedsensor problem or hydraulic pressure problem
- 3、 check oil type and oil level
- 4、 check the belt is broken or not
- 5、 replace speed sensors or hydraulic unit
- 6、 replace pump
- 6、 if still has problem, please inform of the Punch in time.

P1765 Secondary pulley pressure too low

Reaction from TCU :

High side* off, Warning lamp

Man actions:

- 1、 measure the actual and the target pressure in dynamic driving situations like tip ins, launch, ...
- 2、 check oil level and oil type
- 3、 do a proper clutch adaptation (this faultcode can come out when clutch adaptation is not optimal)

	文件 DOCUMENT	编号 Number	D-ASS-224-00-e
		页号 Page	82 / 90

4、 Check car for anything that could result in too low torque from engine: spark plugs, throttle body, catalyst, ... (the older the engine the easier this faultcode could be triggered)

6、 replace oil pump and oil filter

7、 if still has problem, please inform of the Punch in time.

P1766 Secondary pulley pressure too high

Reaction from TCU :

Warning lamp

Man actions:

1、 measure the actual and the target pressure in dynamic driving situations like tip ins, launch, ...

2、 check oil level and oil type

3、 replace hydraulic unit and oil filter

5、 if still has problem, please inform of the Punch in time.

P0701 Double fault requiring high side* open

Reaction from TCU :

High side* off, Warning lamp

Man actions:

check other FCs

P0218 High oil temperature

Reaction from TCU :

Warning lamp

Man actions:

1、 Check oil cooler

2、 Try to reproduce in normal driving condition - if not reproducible, ask customer about driving conditions when the FC occurred.

3、 while trying to reproduce it, you can check the transmission temperature with the tester tool。 T_trans > 120 (longer than the filter time of 30 minutes!); measures to avoid further temperature increase

P1767 Critical oil temperature

Reaction from TCU :

High side* off, Warning lamp

Man actions:

1、 try to reproduce in normal driving condition - if not reproducible, ask customer about driving conditions when the FC occurred (uphill driving or high speed driving?).

2、 check oil cooler

3、 check the oil level and oil type

4、 replace hydraulic unit

5、 if still has problem, please inform of the Punch in time.

P0219 Powertrain speed out of range

Reaction from TCU :

High side* off, Warning lamp

Man actions:

1、 should never occur in principle

	文件 DOCUMENT	编号 Number	D-ASS-224-00-e
		页号 Page	83 / 90

2、 check the fuel cut off of the engine (does it limit the engine speed to 6000 rpm?)

P2766 Primary pulley speed unplausable

Reaction from TCU :

High side* off, Warning lamp

Man actions:

- 1、 check with the tester tool if other speed information (engine speed, output speed, vehicle speed) is also missing; if so, fix that problem first and check if this FC still occurs
- 2、 check with the tester tool the n_s1 signal if the clutch is closed and compare with engine speed (difference should be smaller than 200 rpm) - do this for the whole range of engine speeds (up till 6000 rpm)
- 3、 check wire harness
- 4、 exchange the TCU to make sure
- 5、 check sensor position, angle; same with trigger wheel; check if there's no object in front of the sensor (piece of the belt, or...)
- 6、 replace primary speed sensor
- 7、 replace transmission cable harness
- 8、 replace vehicle cable harness
- 9、 if still has problem, please inform of the Punch in time.

P0721 Secondary pulley speed unplausable

Reaction from TCU :

High side* off, Warning lamp

Man actions:

- 1、 check with the tester tool if other speed information (engine speed, pulley 1 speed, vehicle speed) is also missing; if so, fix that problem first and check if this FC still occurs
- 2、 check with the tester tool the signal (vehicle speed based on n_ab) and compare with vehicle speed (difference should be smaller than 5 kph) -
- 3、 check the vehicle tyre, whether use spare tyre or another type of tyre or not?if yes, please replace original tyre.
- 4、 check wire harness
- 5、 exchange the TCU to make sure
- 6、 check sensor position, angle; same with trigger wheel; check if there's no object in front of the sensor (piece of the belt, or...)
- 7、 replace primary speed sensor
- 8、 replace transmission cable harness
- 9、 replace vehicle cable harness
- 10、 if still has problem, please inform of the Punch in time.

P0944 Insufficient clamping force (VSM)

Reaction from TCU :

Warning lamp, Clutch open

Man actions:

The torque of the engine is too big at the moment the faultcode was activated.
The ECU does not follow the torque reduction request from TCU.

	文件 DOCUMENT	编号 Number	D-ASS-224-00-e
		页号 Page	84 / 90

- 1、 check ECU for faultcodes
- 2、 replace ECU
- 3、 check oil level and oil type
- 4、 do a proper clutch adaptation (this faultcode can come out when clutch adaptation is not optimal)
- 5、 Check car for anything that could result in too low torque from engine: spark plugs, throttle body, catalyst, ... (the older the engine the easier this faultcode could be triggered)
- 6、 replace hydraulic unit and oil filter
- 7、 replace oil pump
- 8、 if still has problem, please inform of the Punch in time.

P0783 Cruise control fault

Reaction from TCU :

Warning lamp, Substitute cruise control support off

Man actions:

If there are no cruise control signals available on CAN, the ECU sends failure flag concerning cruise control:

- 1、 check wiring cruise control button – ECU
- 2、 replace ECU
- 3、 replace TCU

P0782 Winter mode / Stepped AT mode signal fault

Reaction from TCU :

Warning lamp

Man actions:

There is a fault in the wiring of wintermode / Stepped AT button, either SCG, SCB or OC.

- 1、 check wiring wintermode button – TCU
- 2、 replace TCU

P0810(P081A) End of Line (EoL) clutch adaptation not finished

Reaction from TCU :

Warning lamp flashing

Man actions:

A new TCU has probably been installed or SW on the TCU has been updated. Perform a clutch adaptation as described in 2.5. Clutch adaptation procedure. If this is performed correctly, the warning lamp will go out and the error code will disappear after 3 driving cycles (Key off/on).

P1770 Engine speed too low

Reaction from TCU :

None

Man actions:

- 1、 indicates a problem with engine or idle speed controller, check engine, throttle body and ECU faultcodes

P1762 Current stuck

Reaction from TCU :

High side* off, Warning lamp

	文 件 DOCUMENT	编号 Number	D-ASS-224-00-e
		页号 Page	85 / 90

Man actions:

- 1、 check FC15 to FC23 + actions
- 2、 replace TCU with a known good one

P0882 Battery or high side* voltage too low

Reaction from TCU :

High side* off, Warning lamp

Man actions:

- 1、 check the freeze frame if it's a historical fault: it has information on battery voltage when this FC occurred (so you can distinguish if the battery, or the highside caused this FC); if not an historical fault, check it directly = next step
- 2、 check with the tester tool the highside voltage and/or the battery voltage - threshold depends on temperature: look up in software
- 3、 now you have distinguished if it is the battery or the highside. If the battery is the problem: check wiring (fuse, main relay) from battery to TCU
- 4、 if the battery is the problem: replace/check battery
- 5、 if the highside is the problem: check the wiring from the gearbox to the TCU
- 6、 replace TCU

P0883 Battery or high side* voltage too high

Reaction from TCU :

High side* off, Warning lamp

Man actions:

- 1、 check the freeze frame if it's a historical fault: it has information on battery voltage when this FC occurred (so you can distinguish if the battery, or the highside caused this FC); if not an historical fault, check it directly = next step
- 2、 check with the tester tool the highside voltage and/or the battery voltage - threshold depends on temperature: look up in software
- 3、 now you have distinguished if it is the battery or the highside. If the battery is the problem: ask customer if he did a jump start (= 24V) if the battery is the problem: check wiring (fuse, main relay) from battery to TCU。
- 4、 if the battery is the problem: replace/check battery or alternator
- 5、 if the highside is the problem: check the wiring from the gearbox to the TCU
- 6、 replace TCU

P2787 Clutch temperature too high

Reaction from TCU :

Warning lamp, Clutch open

Man actions:

- 1、 Check how many times this FC has occurred. If only one (or a few times), look into freeze frame and ask customer about special driving condition. You can delete the FC.
- 2、 check oil level and oil type
- 3、 do a proper clutch adaptation (this faultcode can come out when clutch adaptation is not optimal)
- 4、 Can only occur when throttle and brake are applied at the same time for a certain period. Delete error code and see if it comes back.
- 5、 replace TCU

	文 件 DOCUMENT	编号 Number	D-ASS-224-00-e
		页号 Page	86 / 90

6、 can be sticking throttle valve, replace throttle valve

P0727 Hardwired engine speed unplausible

Reaction from TCU :

Warning lamp

Man actions:

- 1、 check if the engine reports an error as well (with the tester tool); if so fix this engine problem
- 2、 check wiring input signal TCU - it is a frequency signal (900 rpm engine speed should give a 30 Hz signal, 3000 rpm gives 100 Hz)
- 3、 replace TCU by a known good one
- 4、 replace engine speed sensor

P1761 EDS current fault

Reaction from TCU :

High side* off, Warning lamp

Man actions:

- 1、 check sum of low side currents with high side current, and compare each EDS actual current with its target
- 2、 with the tester tool, check the actual currents of the EDSs with the target currents; if you find one of these being different, check the wiring of this EDS (also inside the gearbox)
- 3、 replace TCU by a known good one
- 4、 replace hydraulic unit
- 5、 replace transmission cable harness
- 6、 replace vehicle cable harness

U0301 Vehicle configuration mismatch

Reaction from TCU :

High side* off, Warning lamp

Man actions:

- 1、 Check if the combination of TCU HW and TCU SW is valid
- 2、 If there is new SW flashed in ECU or TCU: the SW on the newly flashed controller must be wrong (incompatibility between engine and transmission controller)

P0706 Drive mode sensor single line error

Reaction from TCU :

Warning lamp, Substitute lever position

Man actions:

- 1、 check with the tester tool which line is affected and what the problem is; for example line B short cut battery (this FC indicates one of the 4 lines is faulty)
- 2、 check wiring of the affected line between transmission and TCU
- 3、 replace TCU by a known good one
- 4、 replace drive mode sensor
- 5、 replace transmission cable harness
- 6、 replace vehicle cable harness

P0705 Drive mode sensor multiple lines error

Reaction from TCU :

	文件 DOCUMENT	编号 Number	D-ASS-224-00-e
		页号 Page	87 / 90

High side* off, Warning lamp

Man actions:

- 1、 check with the tester tool which lines are affected and what the problem is; for example line B short cut battery and ... (this FC indicates that there is more than one line faulty).
- 2、 check wiring of the affected line between transmission and TCU
- 3、 replace TCU by a known good one
- 4、 replace drive mode sensor
- 5、 replace transmission cable harness
- 6、 replace vehicle cable harness

P0571 Brake signal error

Reaction from TCU :

Warning lamp, Brake signal on

Man actions:

- 1、 check with the tester tool the status of the brake signal
- 2、 check wiring of brake signal
- 3、 check/replace brake switch
- 4、 replace TCU

P0955 Tip mode signals error

Reaction from TCU :

Warning lamp No manual mode

Man actions:

- 1、 check wiring from shifter to TCU
- 2、 replace shifter
- 3、 replace TCU by a known good one

U0415 ABS function error

Reaction from TCU :

Increased clamping level 0*, Substitute detection function of blocked and spinning wheels

Man actions:

check ABS system

U0001 CAN bus off

Reaction from TCU :

Warning lamp, Emergency mode* active, No manual mode

Increased clamping level 1* (highest), Substitute detection function of blocked and spinning wheels , Activate internal driving strategy ,

Substitute engine speed , Substitute engine torque , Substitute engine cooling water temperature, Brake signal on , Accelerator pedal value fixed, Substitute front left wheel speed, Substitute front right wheel speed, Substitute rear left wheel speed, Substitute rear right wheel speed

Man actions:

- 1、 if this problem is present in all other controllers, there is a wiring problem (shortcut between CAN high and CAN low): check vehicle harness
- 2、 if the fault is only stored in the TCU: replace TCU by a known good one

U0121 CAN ABS communication failed

 punch powertrain Gear up for the future	文件 DOCUMENT	编号 Number	D-ASS-224-00-e
		页号 Page	88 / 90

Reaction from TCU :

Increased clamping level 0*, Substitute detection function of blocked and spinning wheels, Substitute front left wheel speed, Substitute front right wheel speed, Substitute rear left wheel speed, Substitute rear right wheel speed

Man actions:

check the ABS controller and the CAN connection from the ABS controller (probably this fault is reported in other controllers as well)

U0100 CAN ECU communication failed

Reaction from TCU :

Warning lamp, Emergency mode* active, No manual mode
Increased clamping level 0*, Activate internal driving strategy, Substitute engine speed, Substitute engine torque, Substitute engine cooling water temperature, Accelerator pedal value fixed, Stop transmitting on CAN

Man actions:

check the engine controller and the CAN connection from the enginecontroller (probably this fault is reported in other controllers as well)

U1012 CAN engine speed signal error

Reaction from TCU :

Warning lamp, Substitute engine speed

Man actions:

check the MCU controller (motor speed sensor and sensor wiring)

U1013 CAN accelerator pedal signal error

Reaction from TCU :

Warning lamp , Accelerator pedal value fixed

Man actions:

check the EMS controller (accelerator pedal sensor and sensor wiring)

U1014 CAN engine torque signals error

Reaction from TCU :

Warning lamp, Emergency mode* active, No manual mode
Activate internal driving strategy, Substitute engine torque

Man actions:

check the EMS controller

U1016 CAN wheel speed error - front left

Reaction from TCU :

Increased clamping level 0*, Substitute detection function of blocked and spinning wheels, Substitute front left wheel speed

Man actions:

check the ABS controller (wheel speed sensor and sensor wiring)

U1017 CAN wheel speed error - front right

Reaction from TCU :

Increased clamping level 0*, Substitute detection function of blocked

	文件 DOCUMENT	编号 Number	D-ASS-224-00-e
		页号 Page	89 / 90

and spinning wheels, Substitute front right wheel speed

Man actions:

check the ABS controller (wheel speed sensor and sensor wiring)

U1018 CAN wheel speed error - rear left

Reaction from TCU :

Increased clamping level 0*, Substitute detection function of blocked and spinning wheels, Substitute rear left wheel speed

Man actions:

check the ABS controller (wheel speed sensor and sensor wiring)

U1019 CAN wheel speed error - rear right

Reaction from TCU :

Increased clamping level 0*, Substitute detection function of blocked and spinning wheels, Substitute rear right wheel speed

Man actions:

check the ABS controller (wheel speed sensor and sensor wiring)

Note:

-**High side***: is the supply voltage for the 3 pressure regulators. When error code occurs and High side is switched off, then the clutch goes open and the vehicle can not move anymore until you do a KEY ON/OFF.

-**Increased clamping level 0***: secondary pressure is at a fixed level, but a higher level than normal operating conditions, lower than max.

-**Increased clamping level 1***: secondary pressure is at a fixed level, maximum pressure.

-**EDS1***: primary pulley pressure regulator

-**EDS2***: secondary pressure regulator

-**EDS3***: clutch pressure regulator

-**Emergency mode***: Also called "Limp Home Mode". Is activated when

-CAN bus is off

-CAN ECU communication failed

-CAN engine torque signals have an error

All engine and ABS related messages will be substituted immediately (safety reactions):

-Throttle pedal = fixed

-Engine torque map instead of the engine torque

-Engine cooling temperature = fixed

-Wheel speeds = substituted by the output shaft speed of the gearbox

-Engine speed = substituted by the hard wired engine speed if available

-The clutch will open and close much more brutal, as if there is no calibration on it

-The maximum engine speed will be limited to 3200 rpm, even if the throttle pedal is fully pressed

-The maximum vehicle speed will be about 90 kph

-The gearbox will shift but within 1 basic driving strategy

	文件 DOCUMENT	编号 Number	D-ASS-224-00-e
		页号 Page	90 / 90

The overall CVT working principle will become BASIC and this is proven to be suitable enough to get to the nearest workshop only

-After 2sec, Tip mode (+/- or Sport) will not be possible anymore and warning lamp will be on.